



BOOKLET 7: WALLS, ROOFS AND FLOORS

TECHNICAL GUIDE FOR NORTHERN HOUSING



TAILORED FOR REMOTE NORTHERN ONTARIO COMMUNITIES





DISCLAIMER

The information in this publication is based on the most current research available to FNNBOA and has been reviewed by housing industry experts. Readers are advised to evaluate the information, materials and techniques carefully and to consult appropriate professional resources to determine courses of action suitable for their situations. The figures and text are intended as general practice guides only. Project and site-specific factors of climate, cost, geotechnical conditions and architecture must be taken into consideration. Any photographs in this book are for illustration purposes only and may not necessarily represent currently accepted standards. Electronic reproduction of content or this publication is made available for information only and is not an official version of the document. Individuals who download these documents do so at their own risk. FNNBOA will not be responsible for any damage to your computer or any of the information on it.

This document, or any discrete portion of this document (such as a chapter or section) may be reproduced for redistribution, without obtaining the permission of FNNBOA, provided that no changes whatsoever (including translation) are made to the text; that the entire document or discrete part is reproduced; that this copyright notice is included in its entirety in any and all copies of the document or any discrete part of the document; and that no use is made of any part of the document, or the name or logo of the owner of the copyright to endorse or promote any product or service. For any use of this document other than reproduction or for the general reference purposes as set out above, please contact: First Nations National Building Officers Association at info@fnnboa.ca. For permission, please provide FNNBOA with the following information: Publication's name, year and date of issue.

First Nations National Building Officers Association
5731 Old Hwy #2, P.O. Box 219
Shannonville, Ontario K0K 3A0
www.fnnboa.ca

Tel (613)236-2040
info@fnnboa.ca

1st Edition [June 2022]

Provided by FNNBOA under license from the National Research Council of Canada



The story of the traditional house

The approach to housing in the north has traditionally involved building to “code minimum,” and using the lowest-cost construction materials. For example, a wall constructed with 2x6 stud framing, OSB sheathing, fibreglass batt insulation, and vinyl siding was common. Although this wall was low-cost to construct, it can easily be more costly from a lifecycle perspective over time.

A lifecycle perspective means thinking beyond the original construction cost alone and considering improvements that help the house last longer and cost less to heat over future years. The overall lifecycle savings can often be more significant than the extra initial construction cost of the improvement. Additionally, given the very high costs of constructing and heating homes in the north, the lifecycle-savings potential is generally much greater than in other parts of the country.

Communities with low-cost heating sources in the improvements can still make the house last longer. There is truth in the saying, “Nothing costs you more than a cheap purchase.”

If the house lasts longer, then over time, the cost per year will be less.

A simplified example would be a house that costs \$200,000 to construct but lasts only 10 years, compared to a house with improved construction that costs \$400,000 but lasts 25 years. The first house construction cost is equal to \$20,000/year, while the improved house construction cost is equal to \$16,000/year. Therefore, even though the house with the lowest initial construction cost appears cheaper, it is in fact \$4,000/year more expensive. That is without considering savings in annual heating costs. Even more of a concern is that the low-initial-cost house will need to be replaced in 10 years time, with all the complications this would involve.

**THIS BOOKLET PRESENTS WHAT THESE IMPROVEMENTS LOOK LIKE:
MAKING A HOUSE THAT LASTS LONGER AND COSTS LESS TO HEAT.**



READ THIS BOOKLET IF YOU NEED TO:

1. Decide which type of roof, walls, and floor to use for a new* *healthy* house in northern Ontario.
2. Decide which type of building materials to use for a new* *healthy* house in northern Ontario.
3. Know more about the critical functions of the different layers of materials in walls, roofs, and floors.
4. Learn more about suitable housing approaches in northern Ontario.

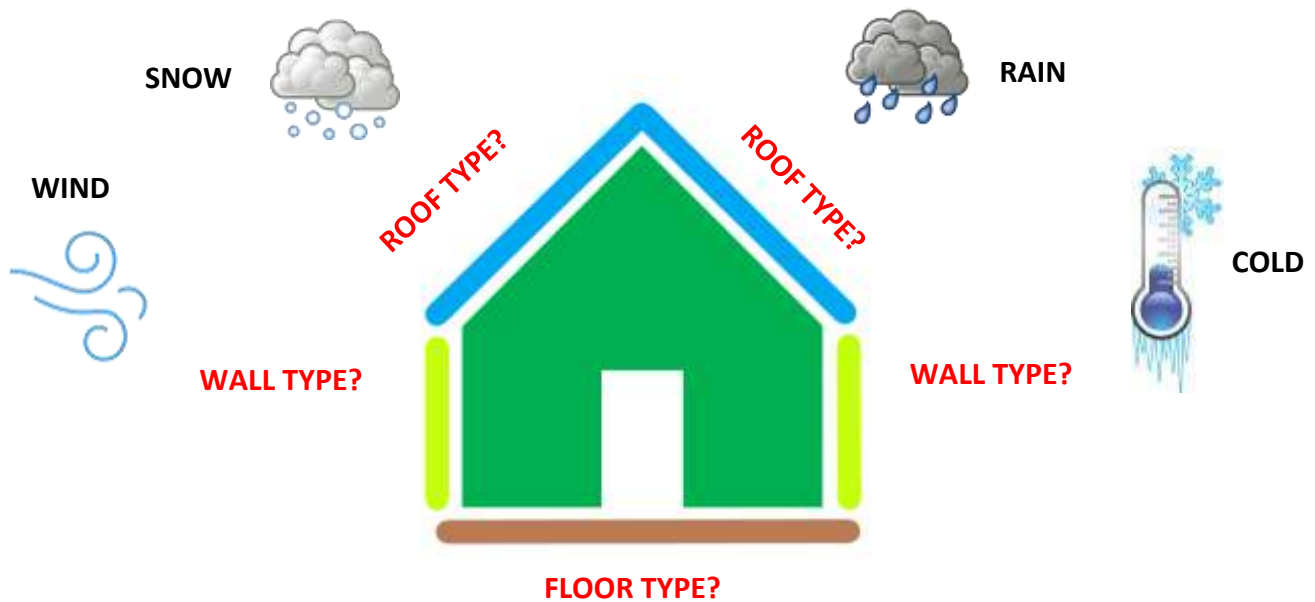

* Although this booklet is for new housing, the concepts can apply to the rehabilitation of existing homes.

The ultimate goal is to advise on housing approaches most likely to result in healthy living conditions and community well-being (i.e. avoid moisture problems, build homes to last a long time, and minimize heating costs).



BOOKLET CONTENTS

	Page
1) Background—The Traditional House	3
2) Solutions—The Recommended Wall, Roof and Floor assemblies	6
3) Quick Selection Guide—Recommendations for Assemblies.....	7
4) Functions of Exterior Walls, Roofs, and Floors	8
More About—Air-Leakage Control	11
More About—Heat Loss and Insulation	14
5) Wall Assemblies—Details.....	16
6) Roof Assemblies—Details.....	60
7) Floor Assemblies—Details.....	80
8) Reference Documents	100
9) Appendix—Lifecycle Costing—Wall Insulation Example	102



SOLUTIONS: Recommended wall, roof, and floor assemblies

PART 1: WALLS

(effective R-value)

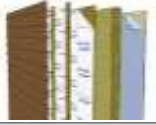

Wall #1: **The Traditional** (R-23)
 (Basic 2x6 stud wall— *minimum code-compliant version*)



Wall #2: **Mooney Wall** (R-31)
 (Insulation added to the **interior** side)



Wall #3: **Triple-Insulated** (R-42)
 (Insulation added to the **interior and exterior** sides)

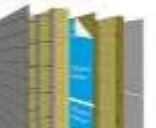

Wall #4: **Split-Insulated** (R-49)
 (Insulation added to the **exterior** side)

PART 2: ROOFS

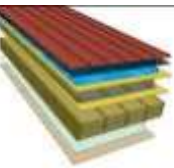

Roof #1: **The Traditional** (R-43)
 (Basic 2x12 rafter roof)

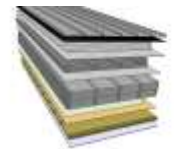

Roof #2: **Mooney Roof** (R-51)
 (Insulation added to the **interior** side)



Roof #3: **I-Joist** highly insulated roof (R-63)
 (16" I-joist rafters and insulation added to the **interior** side)

PART 3: FLOORS



Floor #1: **The Traditional** (R-40)
 (Basic 2x12 lumber joist floor)

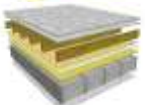

Floor #2: **The Traditional** (hot-floor version) (R-42)



Floor #3: **I-Joist** (hot-floor version) (R-62)



QUICK SELECTION GUIDE—Recommendations for Assemblies

Below is a rough guide for when to use each of the recommended wall, roof, and floor types. Reading this entire booklet will provide more insight into the different options.

PART 1: WALLS

- 1) The Traditional (Wall #1) is recommended for houses heated with an abundant/sustainable supply of low-cost firewood.
- 2) The Mooney Wall (Wall #2) is recommended over the Traditional to reduce yearly heating costs and increase service life.
- 3) The Triple-Insulated (Wall #3) is recommended over the Mooney Wall to reduce yearly heating costs further.
- 4) The Split-Insulated (Wall #4) is most likely to last the longest and cost the least to heat annually.

PART 2: ROOFS

- 1) The Traditional (Roof #1) is recommended for houses heated with an abundant/sustainable supply of low-cost firewood.
- 2) The Mooney Roof (Roof #2) is recommended over the Traditional to reduce yearly heating costs and increase service life.
- 3) The I-joint highly insulated roof (Roof #3) is likely to cost the least to heat annually.

PART 3: FLOORS

- 1) The Traditional (Floor #1) is recommended for houses heated with an abundant/sustainable supply of low-cost firewood.
- 2) The Traditional hot-floor version (Floor #2) is recommended over the Traditional for improved occupant warmth and comfort.
- 3) The I-joint hot-floor version (Floor #3) will cost the least to heat annually and has a warm floor for improved occupant comfort.

Note: Compare the difference in construction costs of the different options with savings in heating cost over the home's life. A sample lifecycle cost comparison is presented in the Appendix of this booklet to help select the best solution, based on the cost of heating in a specific community.



FUNCTIONS OF EXTERIOR WALLS, FLOORS, AND ROOFS

The walls, floors, and roof of a house separate the interior space from the outdoors. Building-code language calls this “*environmental separation*” and includes performance requirements for:

- 1) Air Leakage Control 
- 2) Precipitation Control
- 3) Heat Loss Control
- 4) Vapour Diffusion Control
- 5) Surface Water Management
- 6) Ground Moisture Control
- 7) Sound Transmission Control

-  ♦ **Air leakage** is commonly underestimated as a significant risk for condensation and moisture accumulation resulting in deterioration in walls, roofs, and floors. Air leakage can easily be a leading cause of rot and material damage if the air-barrier system (i.e. continuous 6-mil polyethylene [“poly”] or other) is not carefully thought out and constructed.
- ♦ Roofs and walls are designed to block **precipitation** (rain and snow) from penetrating into the home. The design of the outside layers of the wall and roof assemblies must anticipate and manage the rain and snow properly.
- ♦ Heat moves from warmer areas to colder areas. Insulation slows the rate of heat movement and can effectively control **heat loss**. Proper placement of the insulation and calculation of the right amount of insulation are key to lowering yearly heating costs.
- ♦ **Vapour diffusion** is not commonly an issue, as vapour barriers are a requirement for house construction in cold climates. The most common material is 6-mil poly, which is the right material for northern communities. Proper placement of the vapour barrier in the assembly is key. When the 6-mil poly serves a dual role, as the vapour barrier and designated air barrier, it must be continuous and sealed to also control air leakage.
- ♦ For houses raised off the ground, **surface water** and **ground moisture** are not major issues. However, homes with basements generally require water-management layers on the outside of foundation walls and basement floor to avoid moisture issues.
- ♦ **Sound transmission** is addressed in Booklet 10.

***Note: This guide addresses walls, roofs, and floors as complete architectural assemblies, from their exterior surface in contact the outside weather to the interior finish visible inside the house.**



WEATHER BARRIERS, INSULATION, VAPOUR BARRIERS, AND AIR BARRIERS

Walls, roofs, and floors are much more than the wood-framed structure. They consist of an **assembly** of layers of materials and components. Connection of all of these materials, components, and assemblies is critical for the success of the house design in delivering the required performance. At specific positions within each assembly, different layers are required to meet the environmental separation requirements. These layers include:



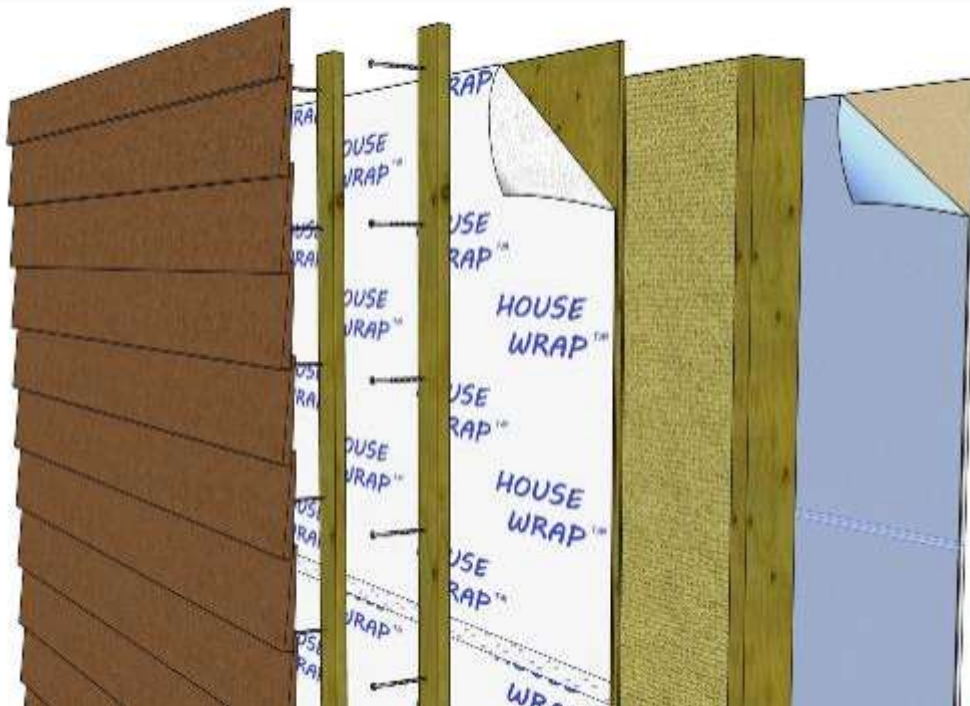

- ✔ **First Weather Barrier** to keep rain and snow out; normally a cladding such as siding on walls and shingles or metal panels for a roof.
- ✔ **Second Weather Barrier** as a back-up layer to prevent incidental rain and snow, that may breach the First weather barrier, from reaching the wood framing; normally sheathing membrane/housewrap for walls, or roofing underlay for roofs.
- ✔ **Insulation** to keep as much heat inside the house as possible.
- ✔ **Vapour Barrier** located on the warm side of the wall, roof or raised floor. It prevents humidity inside the house from moving into the walls, roof, and floor. The most commonly used vapour barrier is a 6 mil thickness polyethylene sheet (“poly”).
- ✔ **Air Barrier** consisting of multiple materials sealed together to minimize air leakage.





BACKUP LAYERS ARE GOOD (EXCEPT FOR THE VAPOUR BARRIER)

In the introduction booklet, the strategy of adding a “backup” is a guiding principle that holds for all layers, except the vapour barrier.

-  Having multiple **vapour barriers** in an assembly creates a vapour trap. This means that any moisture that gets in between the vapour barrier layers is not able to escape/evaporate. The materials will stay wet. This is the main reason that sheathing membranes/housewrap products are vapour permeable. The housewraps allow drying toward the exterior.
-  Multiple **weather-barrier** layers reduce the risk of water penetration. As mentioned above, weather-barrier layers may need to be vapour permeable.
-  Multiple **insulation** layers reduce heat loss.
-  Multiple **air-barrier** layers reduce risks associated with air leakage. As mentioned above, the air-barrier layers need to be vapour-permeable, unless the 6-mil poly vapour barrier is also the designated interior air barrier installed continuously and sealed throughout.



MORE ABOUT—AIR LEAKAGE

Air leakage is often thought of as a heat loss or comfort issue. A drafty house is typically thought of as being uncomfortable and hard to keep warm. However, air leaks can cause significant condensation, moisture accumulation and deterioration in walls, roofs, and floors. The images below and on the next page show what air leakage can do.



Ice buildup at the window header due to air leakage; warm inside air leaking out through a hole in the air-barrier system (where the wall and window meet)

In a cold climate, the air inside a house usually contains much more water vapour than air outside. The interior air is wetter, due to moisture added by showers, cooking, breathing, drying boots and jackets, etc. The air inside a house is relatively warm and moist, and the outside air is relatively cold and dry most of the time. When the humid moisture-laden inside air leaks into a wall, roof or floor assembly, it cools down and will deposit moisture as condensation.



Continued—AIR LEAKAGE

It is important to understand that the direction of air leakage matters. In a cold climate, air that leaks into a house from outside has a drying tendency. Air that leaks out of a house has a condensation/wetting tendency.

It is the outward leakage of interior air that is a concern for moisture issues.

Moisture issues caused by air leakage can be avoided by either making a house airtight or negatively pressurizing the house. The best approach is to make it airtight.

Negatively pressurizing a house means making sure that the direction of air leakage is inward at any gaps or holes in the air barrier. Continuously running kitchen and bathroom exhaust fans is one way to create negative house pressure. Another way is to use a wood-burning stove that generates a “draft” of exhaust air out its chimney. For this reason, a house with a leaky air barrier and heated with a wood-burning stove is less likely to suffer moisture issues, but will have higher heat loss up the chimney.

An airtight house is a house where the “uncontrolled” air leakage, within concealed insulated portions of a wall, roof or floor, is sealed and made airtight. Occupant “controllable” air leakage (i.e. air exchange) is controlled through windows, vents, and ventilation system. An energy-efficient ventilation system is much more energy-efficient than a leaky house with negative pressurization. It is also impossible to control the amount of air exchange within a leaky house and negative pressurization.



Moisture-damaged wall sheathing due to a discontinuous air barrier at the floor plate



Continued—AIR LEAKAGE

⚠ Note: Having **only one** air-barrier layer on the **exterior side** of the wall assembly is risky, as it can allow interior air to flow through pathways into the wall cavity and condense against the cold exterior sheathing. Holes on the interior side will allow air to move within a stud wall cavity filled with fibreglass or blown-in type insulations.

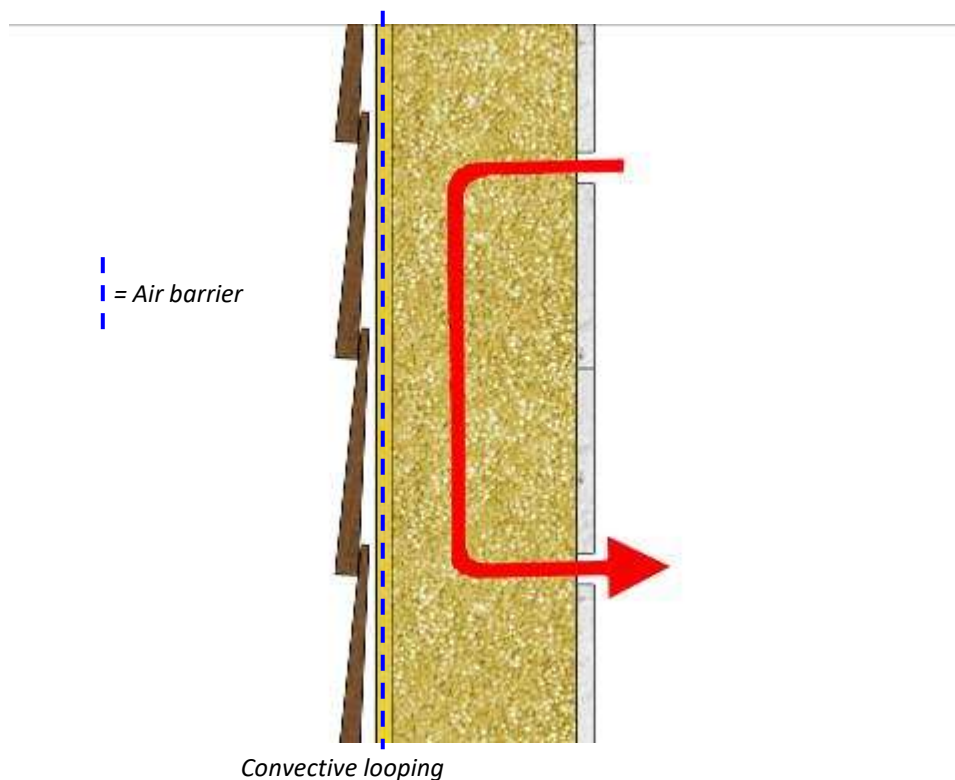

✓ An air barrier on the interior side of the wall is recommended to reduce the risks of this occurring. The walls, roofs, and floors recommended in this guide all have an air barrier toward the interior side of the wall.

Constructing an *additional* air-barrier layer on the exterior side by taping the sheathing or housewrap is encouraged for improved airtightness, but should not replace the interior side air-barrier layer. At least one air-barrier layer toward the interior side of the wall is recommended. This could be a taped and sealed 6-mil poly vapour barrier, the default air barrier specified in the National Building Code. Alternative air-barrier approaches are permitted when designed and installed properly.



MORE ABOUT HEAT LOSS: INSULATION & R-VALUES

R-value is commonly used to describe an insulation product. R-value is a number that represents how well insulation resists heat loss.

- When you add more layers or thicker insulation, you are increasing the R-value.
- “Nominal” R-value is the R-value of the layer of insulation by itself.
- “Effective” R-value is the actual performance when heat losses through the framing and other elements of the overall design are taken into account. These items typically reduce the effectiveness of the insulation as heat flows fast through them as thermal bridges.
- Ultimately, it is more important to think about the “effective” R-value of an overall wall, roof, or floor assembly than the “nominal” R-value of the insulation layers. Note that it is *effective* R-value that is specified in the *National Building Code*.



Two different R-value versions are common: imperial units and metric units. Insulation products are typically sold with large R-value labels using imperial units (for example R-20). However, the building codes list R-values in metric units (for example RSI 3.52). The units of each version are shown below:

R-value (imperial version):
$$\frac{ft^2 \cdot ^\circ F \cdot hr}{Btu}$$

RSI (international system units):
$$\frac{m^2 \cdot ^\circ C \cdot hr}{W}$$

RSI 1.0 is equal to R5.678:
$$1.0 \frac{m^2 \cdot ^\circ C \cdot hr}{W} = 5.678 \frac{ft^2 \cdot ^\circ F \cdot hr}{Btu}$$

For example, an insulation with R20 = 20/5.678 = RSI 3.52 or an RSI 7.0 batt = 7 x 5.678 = R40



HOW TO CALCULATE EFFECTIVE R-VALUE

The graphic below illustrates how the overall *effective* R-value of a wall, roof, or floor is calculated using the Isothermal Planes method. The R-values of the different materials can be found in the Appendix to Part 9 of the *National Building Code*. Effective R-values include the impact of studs and other thermal bridges.

The total R-value from the list below is **R-23.3**.
This is the Effective R-value of the complete wall.

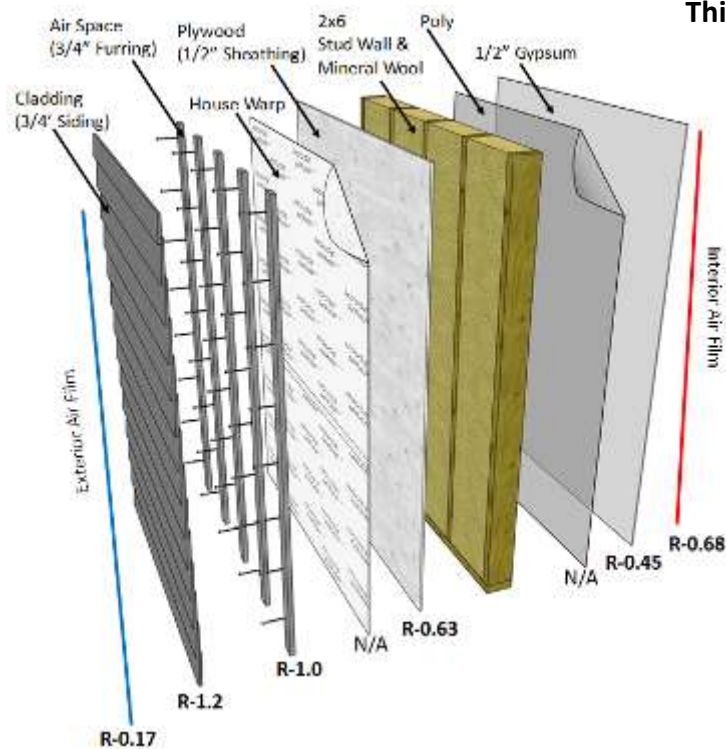

Material R-value List:

- Interior Air Film: **R-0.68** (nominal)
- 1/2" Drywall: **R-0.45** (nominal)
- 6-mil Poly: n/a
- 2x6 Stud Wall & Mineral Wool: **R-19.15 (effective)**
- 1/2" Plywood: **R-0.63** (nominal)
- Housewrap: n/a
- 3/4" Air Space: **R-1.0** (nominal)*
- 3/4" Wood Siding: **R-1.2** (nominal)
- Exterior Air Film: **R-0.17** (nominal)

* The air space is not only air. It also includes 3/4" wood furring, but the R-value of the two materials at this thickness is approximately the same: R-1.0.

The effective R-value of the insulated stud wall needs to be calculated using the Parallel Paths method, as it consists of different materials with significantly different nominal R-values. Notice how the R-value declines when taking into account the framing.

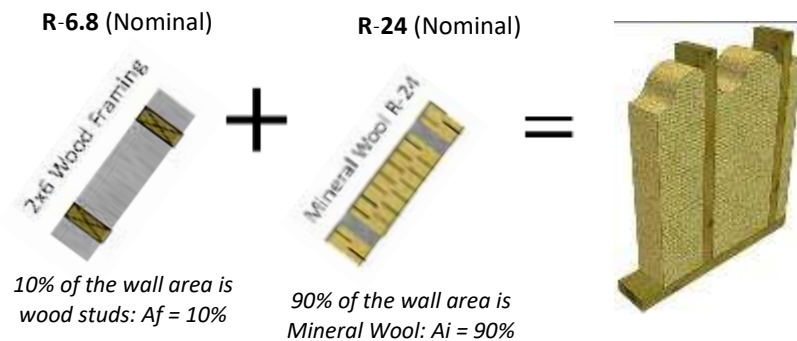

$$\frac{100}{\left(\frac{\% \text{ Area}_{\text{wood studs}}}{R\text{-Value}_{\text{wood studs}}}\right) + \left(\frac{\% \text{ Area}_{\text{insulation}}}{R\text{-Value}_{\text{insulation}}}\right)} = \text{Effective R-Value} = \frac{100}{\left(\frac{10}{6.8}\right) + \left(\frac{90}{24}\right)} = \mathbf{R\ 19.15\ (Effective)}$$



WALL ASSEMBLIES—DETAILS



A premanufactured panel wall being lifted into place



WALL SELECTION: The four recommended wall assemblies presented in this booklet

PART 1: WALLS

(effective R-value) page#

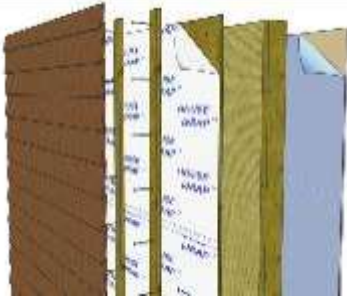

Wall # 1: **The Traditional** (R-23) 33
(Basic 2x6 stud wall)
Minimum code-compliant version

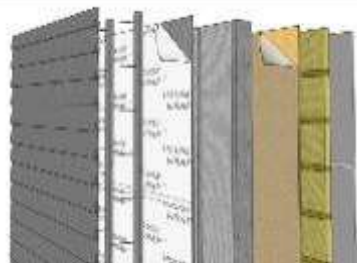

Wall #2: **Mooney Wall** (R-31) 41
(Insulation added to the **interior** side)

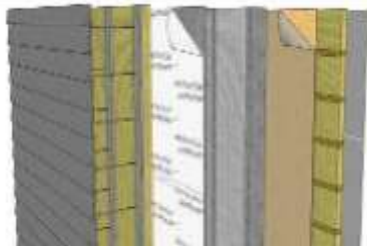

Wall #3: **Triple-Insulated** (R-42) 46
(Insulation added to the **interior and exterior** sides)



Wall #4: **Split-Insulated** (R-49) 49
(Insulation added to the **exterior** side)



DISCUSSION: What are some options for walls?

A wide variety of wall configurations are available to choose from, listed below.

The following symbols are recommendations, starting with less-insulated walls at the top of the list.



Recommended



Generally Not Recommended



Could work well for some communities in certain situations (neutral)



Log: A straightforward log-cabin wall

Log walls are generally not recommended for continuous occupancy, due to low effective R-value and poor airtightness between logs. It requires wood-stove heating and a sustainable, low-cost source of abundant firewood to work well for a community.



The Traditional (Wall #1 in this guide): A basic 2x4 or 2x6 stud-framed wall with batt insulation between studs.

The 2x6 version of the traditional wall is practical for communities that need to build as many houses as they can within limited construction budgets. This option will maximize the number of new homes that can be built at one time by keeping the cost of each house as low as possible. However, heating costs will be higher than any of the other recommended wall approaches.



Deep-Stud: A traditional wall that uses 2x8 or deeper wood studs

Deep-stud walls are generally not recommended. Other wall types cost less to construct, provide a higher effective R-value, and are at lower risk of having moisture-related issues.



Continued—What are some options for walls?



Mooney wall (Wall #2 in this guide): A traditional wall with an insulation cavity added to the interior side of the stud cavity.

This wall is recommended over the traditional wall for communities that can accommodate the additional cost in their construction budget. The Mooney wall is more appropriate than the traditional wall for communities that have high heating costs, such as heating by oil-burning furnace instead of a wood-burning stove.



Deep Stud, Interior Insulated: A deep 2x8 stud wall with an insulation cavity added to the interior side.

This wall type is not recommended for the same reasons stated above for the deep-stud wall.



Triple Insulated (Wall #3 in this guide): A traditional wall with an insulation cavity added to both the **interior and exterior sides** of the stud cavity.

This wall type is recommended for communities where a high effective R-value makes sense from a lifecycle perspective. It is a high effective R-value option that uses conventional house-wrap for ease of installation and lower cost relative to self-adhesive membrane.



Split Insulated: (Wall #4 in this guide): A traditional wall with insulation added to the **exterior side**.

This wall type is recommended for communities where a high effective R-value makes sense from a lifecycle perspective. This wall type has the lowest risk of moisture-related issues, but requires workers who will be patient enough to properly install a self-adhesive membrane with proper accessories.



Continued—What are some options for walls?

 **Exterior Insulated:** A wall with all insulation installed on the exterior side of the studs only.

These are more common for steel-stud-framed walls, since the steel studs allow the heat to bypass the cavity insulation much more easily than wood. If steel studs are being used for the walls of the home, exterior insulation that cuts off the heat flow through the steel studs will make more sense.

 **Double Stud:** Two rows of 2x4 stud wall framing, spaced apart to create a large wall cavity for installing lots of insulation.

This approach can be used to achieve higher effective R-values than the recommended walls in this booklet, but it requires a very airtight air barrier to avoid moisture issues within the wall assembly. It is very good at achieving high effective R-values.

 **Larsen Truss:** Similar to a double-stud approach, except that the outer wall is a truss extending outward beyond the floor's edge.

This approach can be used to achieve higher effective R-values than the recommended walls in this booklet, but also requires a very airtight air barrier to avoid moisture issues within the wall assembly.

 **Structurally Insulated Panels (SIPS):** Typically consists of a layer of foam insulation adhered between two layers of OSB sheathing. Metal insulated panels also exist.

Since these SIPS systems are proprietary they are not all approved for use by the Canadian Construction Materials Centre (CCMC). They are not recommended unless CCMC evaluated for durability of adhesives and panel strength. With a CCMC-evaluated panel, a proper design, transportation, and installation program can be created to ensure the house is constructed correctly. It requires unique solutions to ensure airtightness and rain and snow protection between the panels. Can provide very high effective R-values.

Don't be concerned if this list appears overwhelming. The intent is to show that there are many options to choose from. The following pages will point you in the right direction.



How much insulation does my wall need?

The building code has minimum requirements for the *effective* R-value of a wall used in a house. Different minimum *effective* R-values are listed based on climate zones. Northern Ontario is in the subarctic and arctic climate zones: Zones 7B and 8. The 7B and 8 climate zones correspond to regions with 6,000 or more heating degree days (HDD). Heating degree days is a measure of how much demand on the heating system results from keeping the house above 18°C. The longer the outside temperatures are below 18°C, and the lower the temperatures are from 18°C, the higher the total HDD.

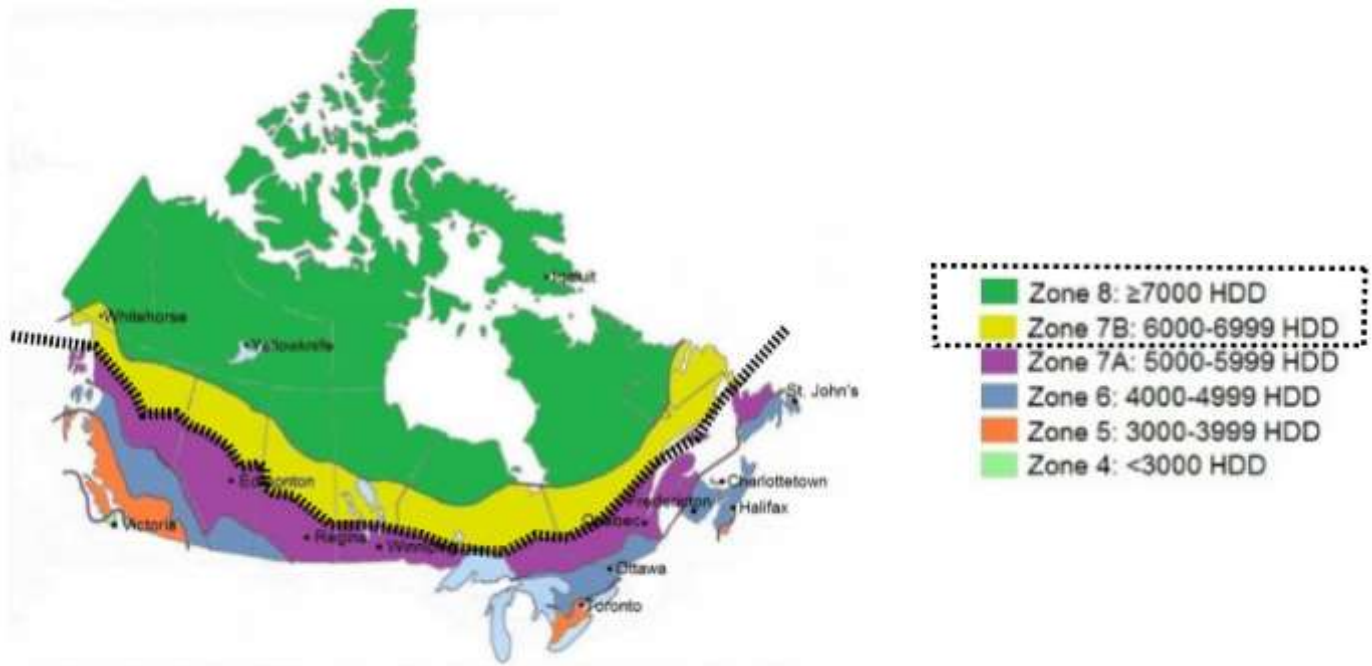

Map of climate zones based on heating degree days
(Zone 8 and 7B have the same minimum effective R-value requirements.)

The *National Building Code* (2020) provides two minimums, one for a house with a heat-recovery ventilator (HRV) and another for houses without an HRV.

- **With an HRV: minimum effective = RSI 3.08 or R17.5**
- **Without an HRV: minimum effective = RSI 3.85 or R22**

The R-17.5 minimum is discouraged, except for small houses with an HRV that are also heated with a wood-burning stove, or where it can be shown to be cost-effective from a lifecycle perspective.

Effective R-22 is recommended as the *default minimum*.



Insulation Options

In addition to all the different options for wall configurations, a number of insulation materials are commonly used in house construction.

⚠ Glass-fibre insulation

- Sensitive to water (easily gets soggy)
- Non-combustible (but not fire-resistant like mineral fibre)
- Lower cost than mineral fibre



Batt version for interior installation typically between studs



Loose-fill version typical for attics, and used in double-stud and Larsen truss walls



Board (rigid) version for exterior side application

✓ Mineral fibre insulation: Common (recommended)

- Water-resistant (hydrophobic; resists getting soggy)
- Highly fire-resistant
- Reasonable R-value per inch
- More expensive than glass fibre
- Dimensionally stable



Batt version for interior installation typically between studs



Board (rigid) version for exterior installation



Continued—Insulation Options

⚠ Cellulose loose-fill insulation: Generally not recommended for the north in attics:

- Primarily made from recycled newspaper
- Very low cost
- Vulnerable to water and settling, and has additives for fire/smouldering resistance



Cellulose loose-fill insulation

⚠ Open-cell spray polyurethane foam: Also called “low density” or “½ pound” spray foam

- Combustible
- Vapour permeable (it allows water vapour to move through it)
- Lower R-value per inch than closed-cell spray foam (around R3.5 per inch)
- Lower cost than closed-cell spray foam



Open-cell spray foam



Continued—Insulation Options

⚠ Closed-cell spray polyurethane foam: Also called “medium” or “two-pound” spray foam:

- Combustible
- installation requires special training and special equipment
- Acts like a vapour barrier (if thicker than 2”)
- High R-value per inch
- Expensive



Closed-cell spray foam

⚠ Polyisocyanurate foam board insulation: Used in roofing:

- Less combustible than other foam plastic insulations
- R-value decreases in cold temperatures
- Very water-sensitive
- Shrinks and expands a lot with changes in temperature (gaps open between boards)



Polyisocyanurate foam board



Continued—Insulation Options

⚠ Expanded Polystyrene (EPS) insulation: Foam coffee cups are EPS:

- Combustible
- Dissolved by solvents (primers, gasoline, etc. “melt” EPS)
- Less expensive than extruded polystyrene (XPS) and mineral fibre
- Lower R-value than XPS—around the same as mineral fibre—around R4 per inch
- Has some vapour resistance (may act as a vapour barrier)

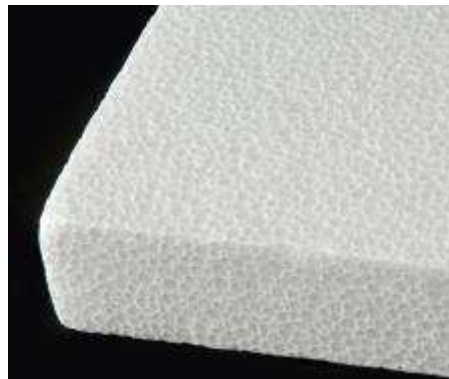

EPS foam board

? Extruded Polystyrene (XPS) insulation: The best insulation for below-ground:

- Combustible
- A good R-value per inch (around R5 per inch)
- More rigid and stiff than EPS
- Can act as a vapour barrier
- Low water absorption

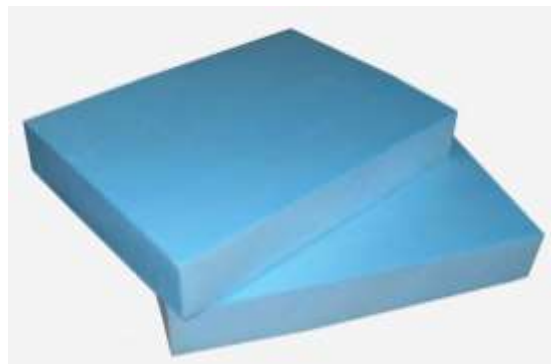

XPS foam board



Continued—Insulation Options

- ✔ **Mineral fibre insulation is the recommended insulation type in this guide. The recommended walls in this booklet are all shown with mineral fibre *insulation*, except for insulation that is in contact with the ground (surface or below ground). It is recommended that only XPS board foam be used for this.**

However, where continuous permafrost is widespread, this guide recommends that houses be raised and not in contact with the ground, so XPS should not be needed.



Batt mineral fibre between wall studs



Board mineral fibre installed on the exterior of a wall



XPS installed on the exterior of a foundation wall being built in the south, for reference only

Compared to glass fibre insulation, mineral fibre insulation has a higher R-value per inch, is less sensitive to water, more fire-resistant, forgiving to install, and typically has better sound-blocking properties.

The main reason that mineral fibre is recommended over other insulation options is that it is highly fire-resistant. Most northern communities have limited fire-fighting ability. Building with fire-resistant insulation is one of the easiest ways to reduce the risk of house fires burning out of control before fire-fighting teams can arrive.

Terminology:

Glass fibre insulation: Fibre insulation consisting of silica mineral

Mineral fibre insulation: Fibre insulation made from volcanic rock slag (a mixture of minerals)



Cladding Options

Vinyl siding and wood siding are well-known claddings. Other options include corrugated metal panels, pre-finished engineered wood, fibre cement, and aluminum siding. Some of these claddings are much better than others for the north. The ideal cladding material for a house in a remote northern community needs to have the following properties:

- Withstands impacts and strong winds at very cold temperatures
- Tolerates some foundation movement
- Is not excessively heavy
- Is straightforward to install and repair
- Has a low coefficient of thermal expansion and contraction
- Is not moisture sensitive

When considering these requirements, solid wood siding is a good reference point. For example, if the material is much heavier than solid wood siding, such as brick, it should be avoided.

The following materials are poorly suited for the north for at least one of the reasons listed above:

- ⚠️ • **Vinyl siding:** easily cracks with impacts in extreme cold.
- **Brick:** is excessively heavy to ship and prone to cracking with foundation movements.
- **EIFS:** installation requires skill and warm temperatures.
- **Stucco:** is prone to cracking with foundation movements, and installation requires skill.
- **Aluminum siding:** expands and contracts a lot with temperature changes, and a lot more than steel siding materials.
- **Composite or engineered wood siding:** composite materials are generally more moisture sensitive than solid wood.
- **Fibre cement board:** is significantly heavier than wood. Silica dust generated during installation can cause lung irritation or damage if a respirator is not used while cutting the boards.



Continued—Cladding Options

✔ **Prefinished solid wood and prefinished steel cladding** are recommended. These are the two most common cladding materials, with an established history of acceptable performance in the north. Both options are straightforward to install and repair. The main advantage of using steel cladding over wood is that it is non-combustible. Steel cladding is recommended for communities that want to reduce fire risk as much as possible. It comes in different ribbed profiles and there are different solid-wood siding styles, such as “clapboard” and “board and batten.”



Clapboard wood siding (section side view)



Steel cladding



Board and batten wood siding (section top view)





Continued—Cladding Options

One of the main drawbacks of standard wood siding instead of metal siding is that wood is combustible. However, one version of wood siding has a lower fire risk than common solid-wood siding: **shou sugi ban (charred wood)**. The pre-burning of the wood planks leaves a charcoal surface. The charcoal is the last component of the wood to burn and requires higher temperatures to ignite than uncharred wood. This old type of construction has seen a comeback in recent years.



Shou sugi ban (charred wood) wood siding



Shou sugi ban (charred wood) on a house

Charred wood siding originated in Japan a few hundred years ago. The name shou sugi ban comes from the Japanese. The planks are typically charred by making a triangular tube with three planks and directing a flame down the tube's centre.



Wood siding being charred



Wood siding being charred



Plywood or OSB sheathing?

A long time ago, wall sheathing consisted of diagonal boards. Then plywood became the primary form of sheathing. Plywood is manufactured by peeling logs into a thin layers (veneer). Now, oriented strand board (OSB) is the most common type of sheathing used in house construction in many regions.



Plywood



Oriented strand board (OSB)

The main reason OSB is gaining popularity is that it can be less expensive in many markets and can be made from smaller trees. Plywood requires larger trees, and high-quality wood veneer is at a premium, since veneers are also used to make laminated veneer lumber (LVL). OSB is made from aspen, which is fast growing and not high-value fibre but can be made into wafers or strands. This means that OSB adds value to a resource that has little value otherwise.

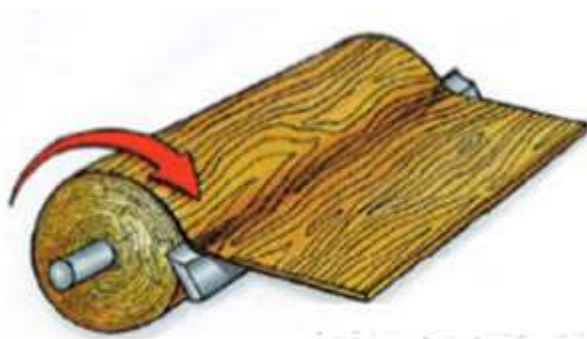

Plywood manufacturing requires larger logs



Wood strands used to make OSB



Continued—Plywood or OSB sheathing?

✔ The recommended walls in this booklet are all shown with *plywood* sheathing.

Plywood is the recommended sheathing type in this guide. OSB may cost less, and is more common for sheathing in many regions, but it is also more moisture-sensitive.

Note: some of the recommended walls in this booklet include a thin layer of OSB sheathing over the vapour-barrier layer to form part of the air-barrier system. This OSB layer is located toward the warm interior side of the wall, where it is less likely to get wet during construction. It is also covered with insulation and gypsum board, so it is less likely to see moisture once occupied.

Unfortunately, OSB is more moisture-sensitive than plywood and has a higher risk of mould issues. In general, OSB needs to be carefully protected and kept dry, even during construction, to avoid mould issues or swelling. Plywood should also be protected from getting wet but can tolerate some wetting for short periods.

Plywood sheathing is a better choice for conditions in the north.



OSB with mould growth in a new house being constructed

OSB is a positive development overall for the construction industry, as it has helped reduce construction costs. It makes sense for widespread use in urban areas with lots of houses, where the risks are more easily managed, and the potential negative consequences less likely.



Interior Drywall Options

⚠ Gypsum wallboard (or drywall) is the most common material used for the interior wall surface in house construction. The default and most common version of gypsum board has a paper layer on its surface (i.e. paper-faced). Unfortunately, the paper is also highly moisture-sensitive, and mould easily develops when the paper gets wet. Paper is an ideal food for mould. In places like bathrooms, where a wall is more likely to get wet, paper-faced gypsum board has a high risk of mould growth.



Common paper-faced gypsum board



Mould growth on a paper-faced gypsum wall

Fortunately, there are versions of gypsum board that avoid using paper. Instead, they are coated with fibreglass mats and are much more resistant to mould growth. The fibreglass mats also make the gypsum board more impact-resistant.

Fibreglass-faced gypsum board is often marketed and labeled as “moisture and mould resistant.”

✓ Fibreglass-faced gypsum board is recommended over standard paper-faced gypsum board for all walls throughout the house.

It should be considered for bathrooms and kitchens, where significant moisture is produced from such activities as cooking and showers.



Fibreglass-faced gypsum board



WALL #1: THE TRADITIONAL

The traditional wall consists of wood stud framing with all insulation installed between the studs. It is the lowest cost and simplest wall to construct of the recommended wall types, and can be found in houses all across Canada.

The original version of the traditional wall consisted of 2x4 wood stud framing. Today, the default is framing with 2x6 wood studs, to make enough room for the required insulation.

The traditional wall is best for communities that have an abundant supply of low-cost firewood for heating, or another source of low-cost energy.



WALL #1: The Traditional R-23 (EFFECTIVE)

(Basic 2x6 stud wall—a version that meets code minimum)



① 3/4" Wood Siding

→ **First Weather Barrier**

② 3/4" Rainscreen Cavity w/ 1x3 Strapping

③ Housewrap (all laps taped)

→ **Second Weather Barrier (+ Air Barrier)**

④ 1/2" Plywood

⑤ 5 1/2" Mineral Fibre Batt

⑥ 2x6 Wood Studs @ 16"

⑦ 6-mil Polyethylene Sheet

→ **Vapour Barrier + Air Barrier**

⑧ 1/2" Drywall—Fibreglass-faced



The Insulation Layer

Traditional wall with insulation layer highlighted

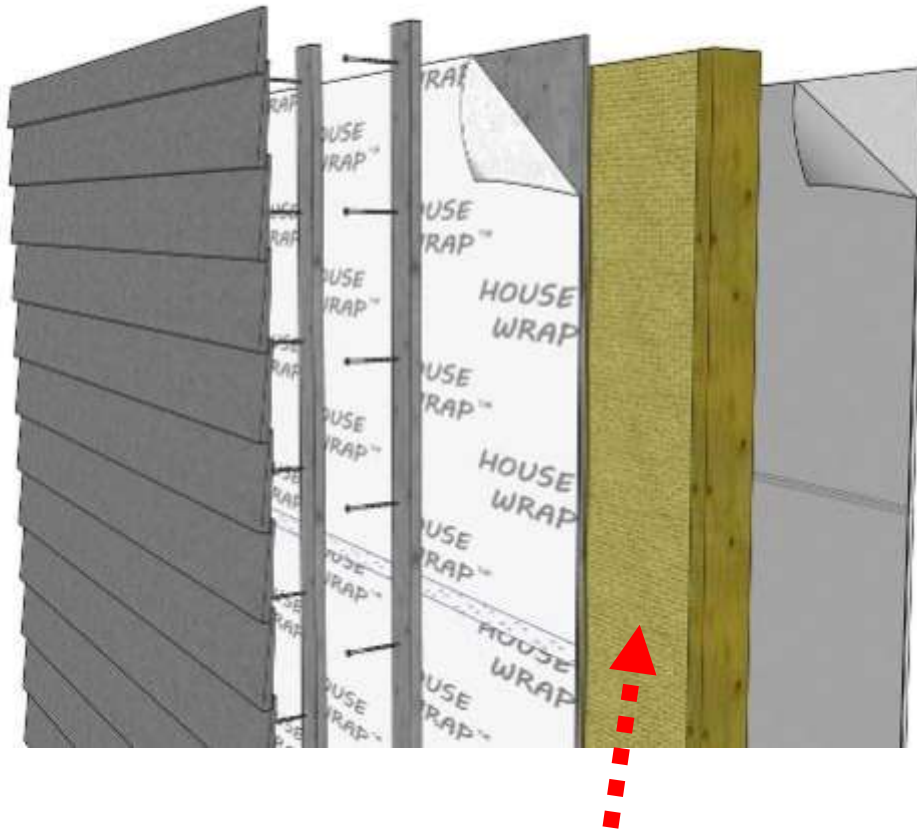

Mineral fibre batt insulation that is **R-24 nominal** and **measures 5.5"** thick must used. (Fibreglass batt insulation does not work for the effective R-22 minimum requirement.)

Only certain higher R-value insulation products can be used in the traditional wall to meet code minimum of effective R-22.



The Air-Barrier Layer

The 6-mil polyethylene (poly)* is the **vapour barrier**, but also functions as part of the **air barrier**. The **tape and sealant** are the other parts of the air barrier needed to make it airtight.

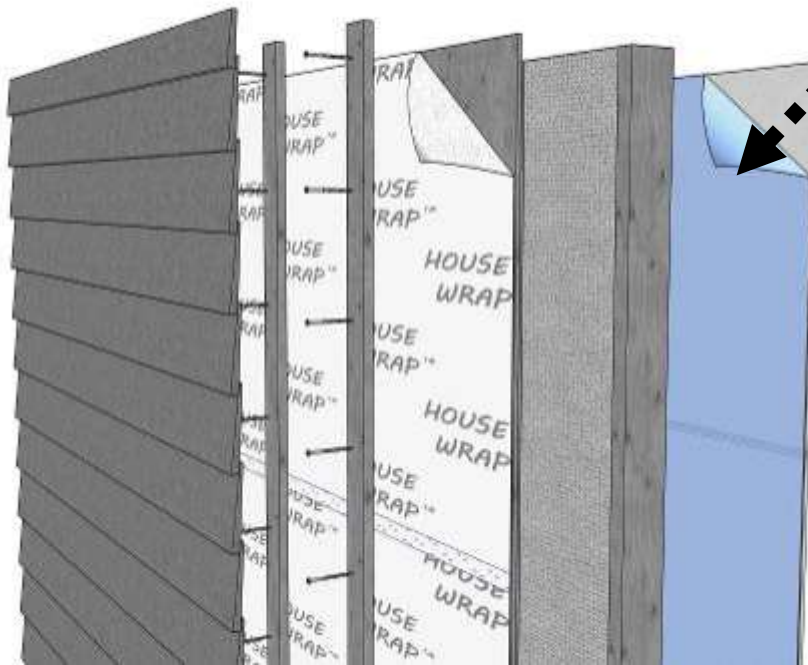

Traditional wall with the air-barrier layer highlighted

To achieve an air seal with the 6-mil poly, tape and acoustical sealant is used at laps and perimeters. However, this layer is often punctured by electrical boxes and other penetrations. This is why these penetrations must be taped/sealed.

⚠ Once the house is occupied, nails from hanging paintings, clocks, etc. will likely puncture the air barrier. Over time, these holes will increase the risk of moisture issues related to air leakage.

***Terminology clarifications: *6-mil polyethylene (poly):**

- Sheet thickness is 6 mil = 0.006 inches (six thousandths of an inch), also 0.15mm in metric.
- Polyethylene is a clear plastic material and must be CGSB-certified to ensure durability, and bear the CGSB certification mark for use in house construction.



Continued—The Air-Barrier Layer

Constructing additional layers to be airtight will reduce the risks associated with some limited punctures in the 6-mil poly. Below are two recommended options for additional air-barrier layers:

- ✔ A well-taped exterior housewrap acts as an additional airtight layer.
- ✔ Taped plywood sheathing can serve as an additional air-seal layer. Consider using urethane floor adhesive to glue the sheathing to the wood studs. This will also help increase airtightness.

This guide recommends that an additional air-barrier layer be included in the construction of the traditional wall, to make the house more airtight. It will help the house last longer.



Provide an Air Space between the First and Second Weather Barrier

In the past, the first weather barrier (siding) was often fastened directly to the second weather barrier (housewrap), without the benefit of an airspace. Now, adding a space between the siding and the housewrap is standard practice in many regions, as it greatly reduces the risk of leaks and deterioration. This space is commonly called a rainscreen and is usually created with vertical wood strapping.

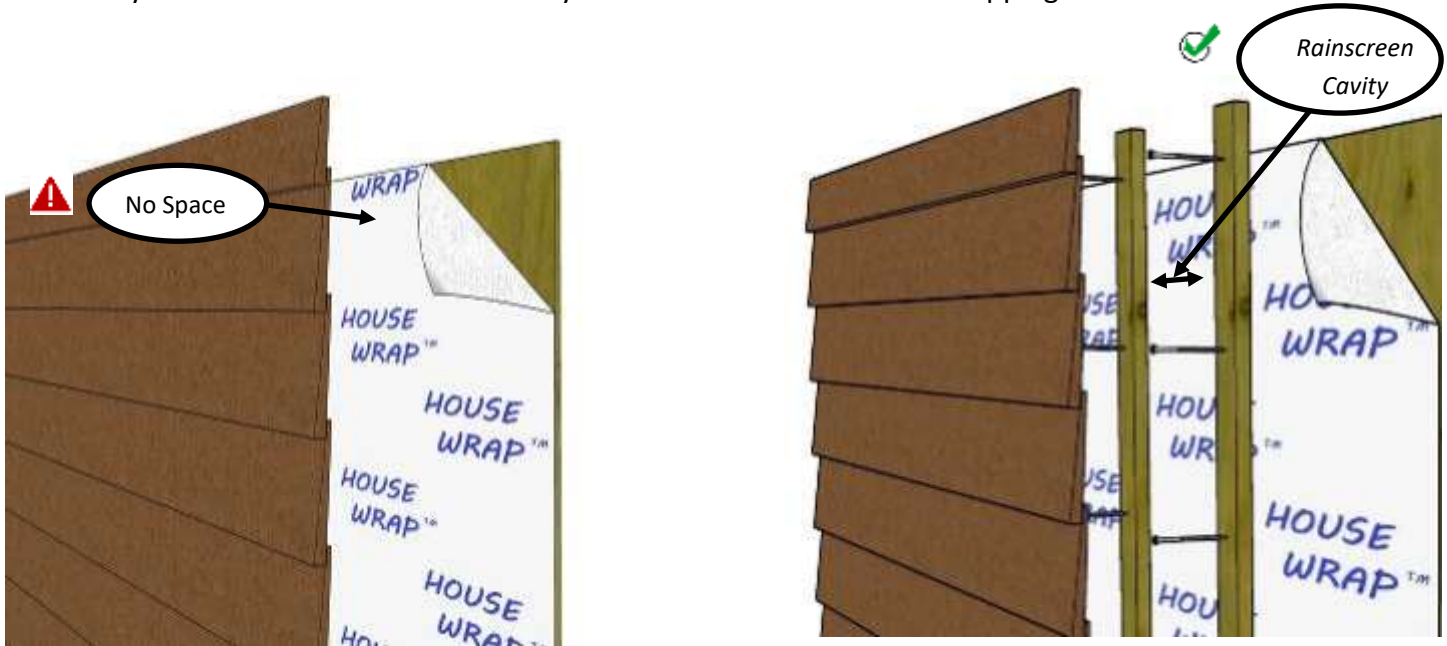

Siding installed directly to housewrap

Siding installed on strapping to create a rainscreen cavity

With a rainscreen, exterior moisture is less likely to reach or get past the housewrap. Any moisture that gets past the siding will drain down the airspace and dry much more quickly. The rainscreen also increases the ability of the wall to dry to the outside if the housewrap or plywood behind gets wet. The lifespan of wood siding is also extended with a rainscreen, as it is able to dry in both directions.

This guide recommends use of a rainscreen for all walls. It will help the house last longer.

Terminology clarifications:

First weather barrier: (called “cladding” in other construction literature)

Second weather barrier: (called “water-resistive barrier” (WRB) in other construction literature)



Durable Materials

Note that the traditional wall shown on page 34 uses the recommended materials that are likely to last longer and have lower risk of issues compared to other materials.

- **Wood siding** (steel cladding is also a good choice)—recommended instead of other materials, such as vinyl siding
- **Plywood sheathing**—recommended instead of OSB
- **Fibreglass-faced drywall**—recommended instead of paper-faced gypsum board

When these materials are used together, the house is much more likely to last longer than if more common but less durable materials are used.



WALL #2—MOONEY WALL

The Mooney wall consists of an added layer of insulation on the interior side of the traditional wall. It is commonly used in many northern communities. After the traditional wall, it is the next lowest in cost and next simplest wall to construct, of all the recommended wall types.

It is a great option for reducing heating costs without increasing the cost of construction too much.

This guide encourages using the Mooney wall over the traditional wall, as it is more likely to have a lower lifecycle cost. (Refer to the Appendix for sample calculations to determine the most cost-effective option for your project and community).



WALL #2: MOONEY WALL R-31 (EFFECTIVE)

(Insulation added to the interior side)

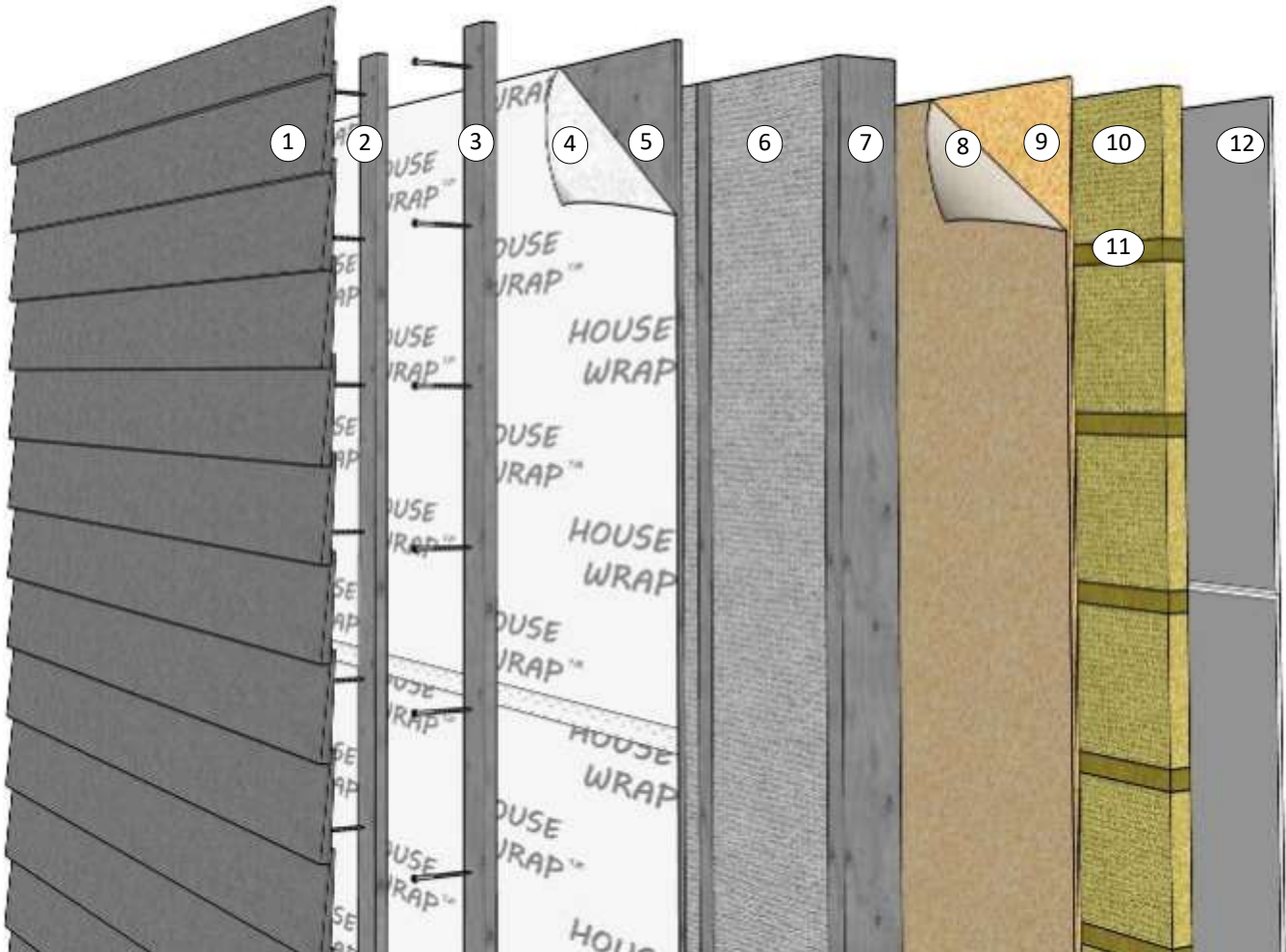

- ① 3/4" Wood Siding
→ **First Weather Barrier**
- ② 3/4" Rainscreen Cavity
- ③ 1x3 Strapping
- ④ Housewrap
→ **Second Weather Barrier (+ Air Barrier)**
- ⑤ 1/2" Plywood
- ⑥ 5 1/2" Mineral Fibre Batt
→ **Insulation, R-24 (nominal)**

- ⑦ 2x6 Wood studs @ 16"
- ⑧ 6-mil Polyethylene Sheet
→ **Vapour Barrier + Air Barrier**
- ⑨ 1/4" OSB with Taped Joints
→ (Air Barrier)
- ⑩ 2 1/2" Mineral Fibre Batt
→ **Insulation, R-10 (nominal)**
- ⑪ 2x3 Wood Studs, horizontally @ 16"
- ⑫ 1/2" Drywall-Fibreglass-faced



The Insulation Layer

The effective R-value of the overall wall is significantly increased by adding a **2 ½” service cavity** to the basic wall and filling it with batt insulation.

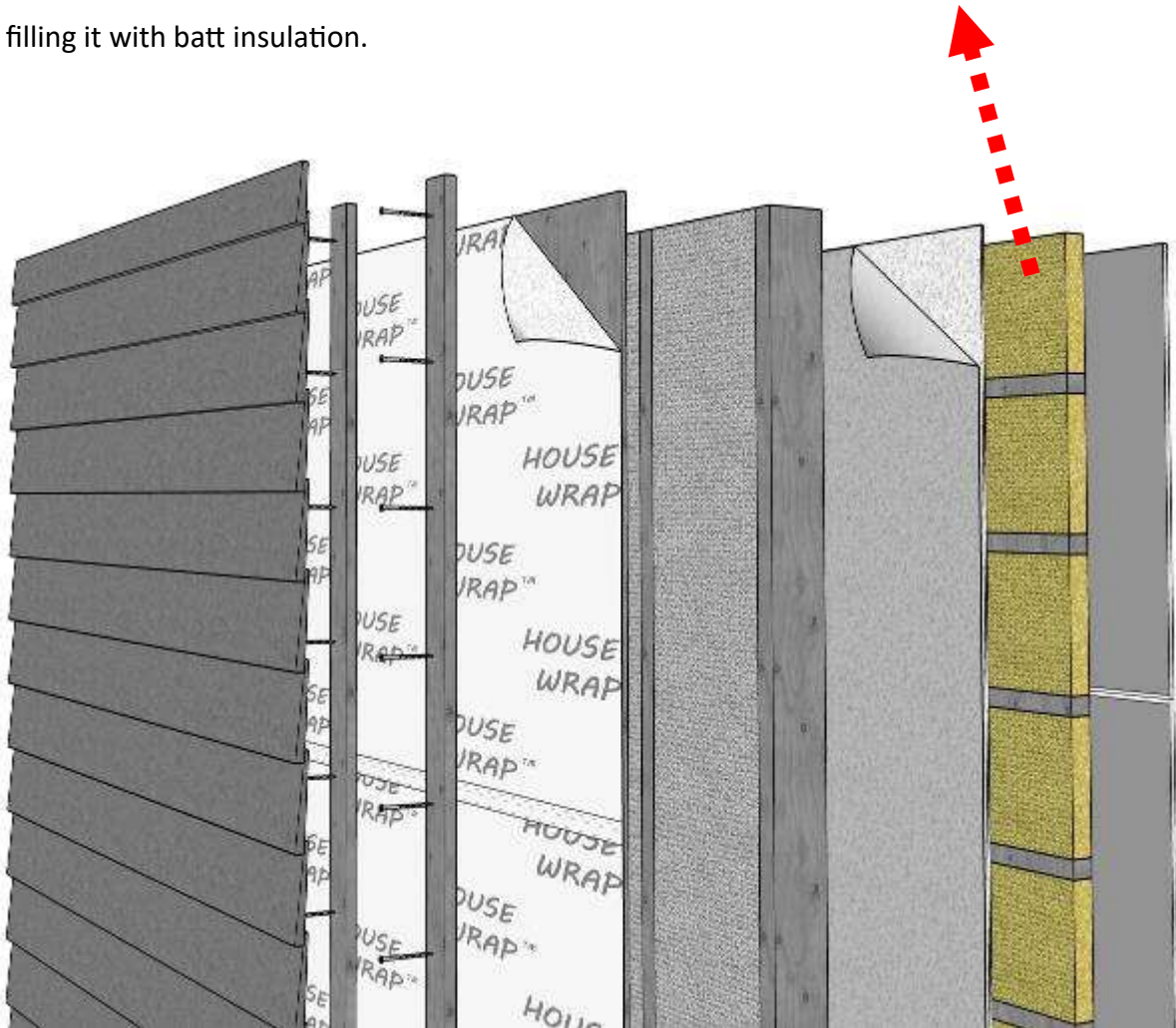

Mooney wall with additional insulation layer highlighted

The 2x3 stud framing runs horizontal to the vertical 2x6 studs. The insulation in the service cavity blocks most of the heat loss bridging through the 2x6 studs from reaching the interior drywall finish.



The Air-Barrier Layer

As in the traditional wall (Wall #1), the 6-mil polyethylene sheet (poly) is used as part of the air barrier.

The main advantage of the 2x3 service cavity is that the air-barrier layer is recessed so that it is better protected from being punctured. Also, importantly, with the poly recessed, electrical wiring and electrical boxes within the 2 ½” service cavity will not disrupt its vital function as a continuously sealed barrier against air leakage. Once the home is occupied, any nails from hanging objects on the wall into the horizontal 2x3s will be much less likely to puncture the air barrier and cause air leaks.

For additional air-barrier protection, the poly air barrier is covered with ¼” OSB protection board.

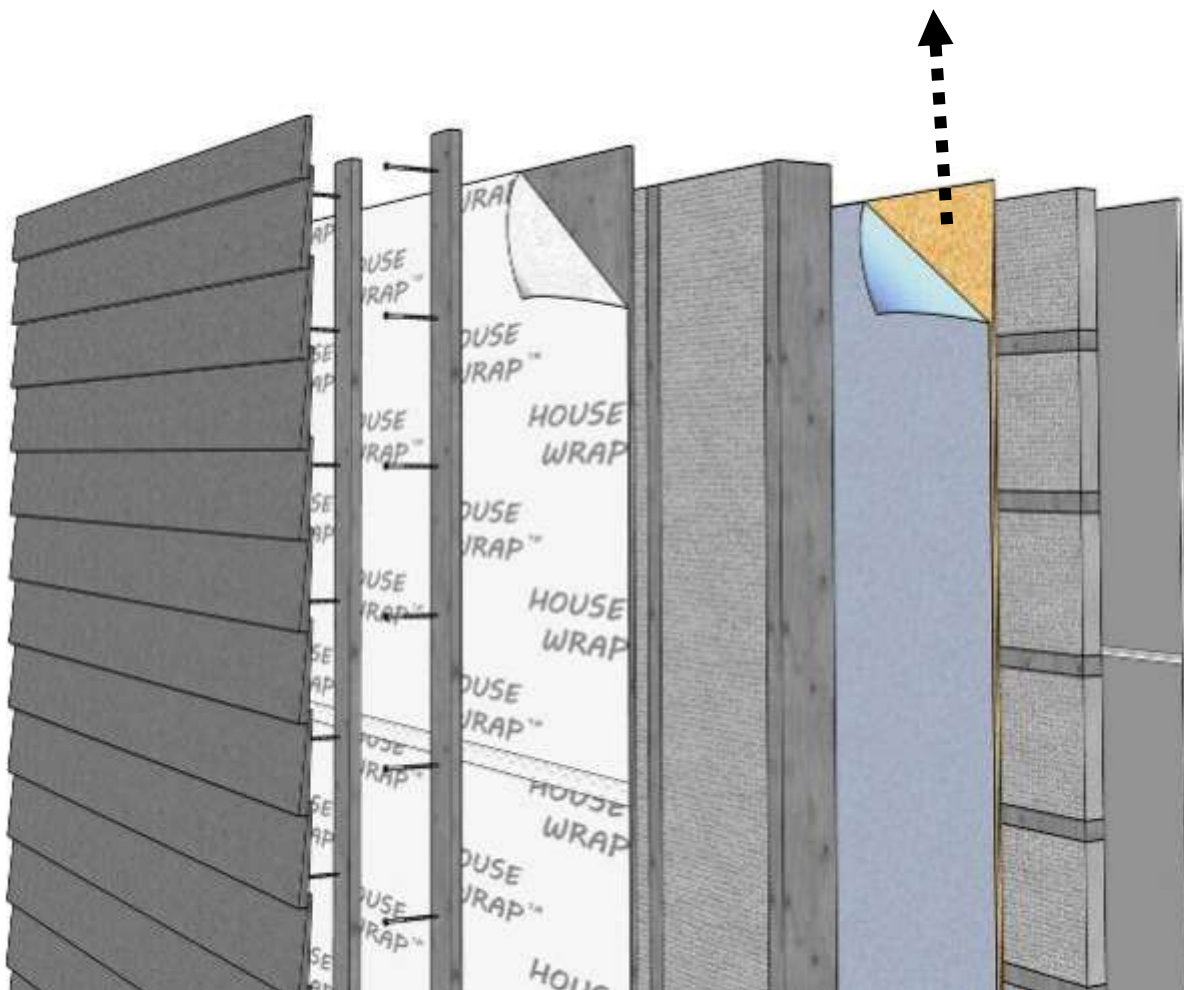

Mooney wall with 1/4” OSB protection board highlighted



Continued—The Air-Barrier Layer

If possible, install the poly and horizontal 2x3 studs on the interior side of the exterior wall before building interior walls. This will help the poly air seal be continuous.

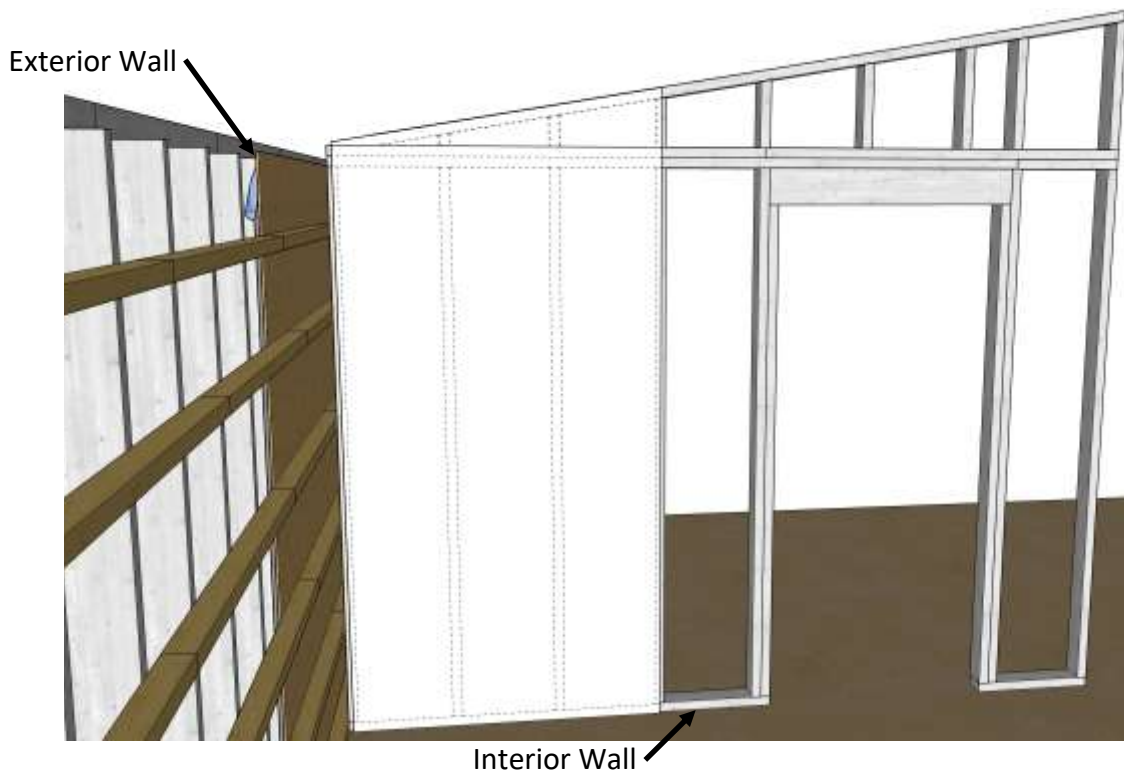

Exterior wall with service cavity's horizontal studs installed before the interior wall

Refer to the Traditional wall (#1) sections on the air barrier, rain screen and durable materials. The content in these sections also applies to this Mooney wall.



WALL #3—TRIPLE-INSULATED

The triple-insulated wall involves a layer of insulation added to the exterior side of the Mooney wall.

This wall has a very high R-value, so that lifecycle heating costs will be very low. It uses common housewrap and is straightforward to construct.

Refer to the Appendix for sample calculations to determine the most cost-effective option for your project and community.



WALL #3: TRIPLE INSULATED R-42 (EFFECTIVE)

(1 insulation added to the interior & exterior sides)

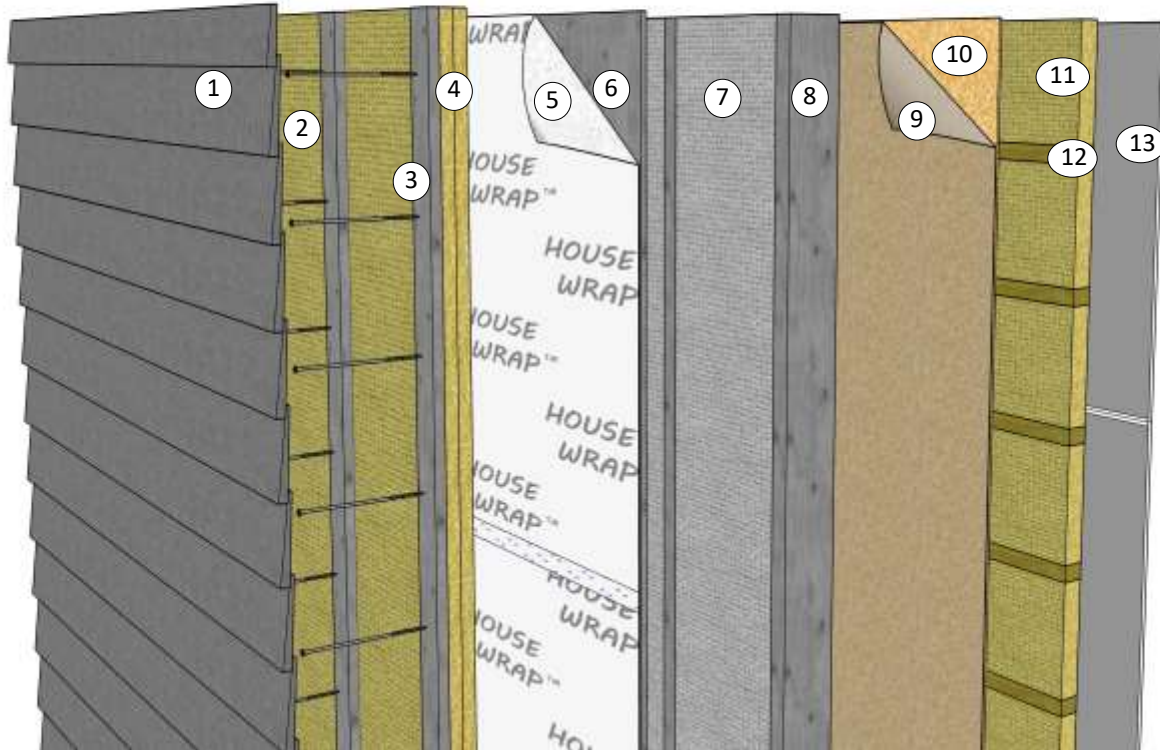

- ① Wood Siding
→ **First Weather Barrier**
- ② ¾" Rainscreen Cavity
- ③ 1x3 Strapping
- ④ ***2½" Mineral Fibre Boards; 2 x 1¼"
→ **Insulation, R-10.5 (nominal)**
- ⑤ Housewrap
→ **Second Weather Barrier (+ Air Barrier)**
- ⑥ ½" Plywood
- ⑦ 5½" Mineral Fibre Batt

- ⑧ 2x6 Wood Studs @ 16"
- ⑨ 6-mil Polyethylene
→ **Vapour Barrier + Air Barrier**
- ⑩ ¼" OSB with Taped Joints
→ (Air Barrier)
- ⑪ 2½" Mineral Fibre Batt
→ **Insulation, R-10 (nominal)**
- ⑫ 2x3 Wood Studs, horizontally @ 16"
- ⑬ ½" Drywall - fibreglass-faced

*** Warning: Exterior foam-board insulation is **not recommended**. Using foam-board insulation would block any potential drying and create a water-vapour trap. It is also flammable. Mineral fibre board insulation is specifically and intentionally recommended for the exterior insulation in this assembly as it is "vapour open" and allows drying toward the exterior.



The Insulation Layer

Limiting the exterior insulation to 2 ½” does limit the overall wall R-value. However, it makes it possible to use shorter, more commonly available 4” screws to secure the strapping to the studs. With 2x3 blocking at window and door openings, window and door details are relatively conventional and straightforward. This makes the installation significantly less complex.

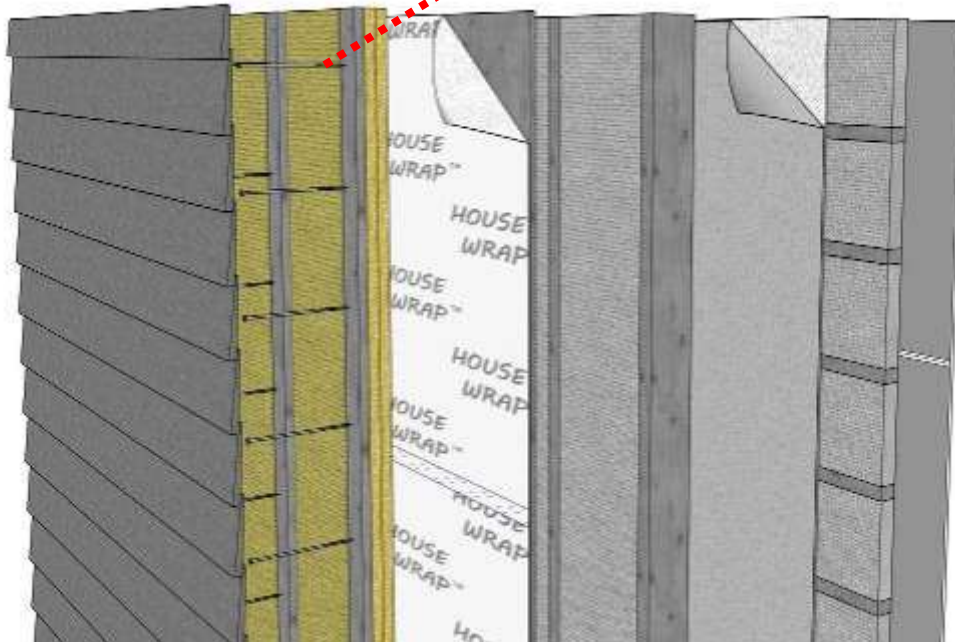

The triple-insulated wall with the exterior insulation highlighted

The effective R-value can be increased by adding more exterior insulation. Another extra 1” of board mineral fibre for a total of 3 ½” of exterior insulation would increase the effective R-value to R-47 . This does require 5” screws to secure the strapping, but it would allow the use of 2x4 blocking at windows and doors to keep their detailing relatively conventional.

Note: R-65 effective is possible if 8” of exterior insulation is installed, which would give this wall the highest effective R-value of all the recommended wall types.

Refer to the Traditional Wall (#1) and Mooney wall (#2) sections on air barrier, rain screen, and durable materials. The content in these sections also applies to this wall.



WALL #4—SPLIT-INSULATED

The split-insulated wall consists of adding layers of insulation to the exterior side of a traditional wall framed with 2x4 studs. This is the highest R-value wall of the recommended wall types and will have the lowest lifecycle heating costs.

This is the only wall that would likely not suffer deterioration due to interior air leaking out a hole drilled in the wall, as the point of condensation would most likely be on the exterior side of the Second weather barrier. The majority of the insulation in this wall is on the exterior side of the Second weather barrier and can tolerate potential accidental wetting.

From a purely technical perspective, this is the best of the recommended wall types, but it is also the most expensive. Installation involves using peel-and-stick (self-adhesive) membrane, which requires more care and skill to install than standard housewrap. Thick multi-layer exterior installation also requires more care and skill to install than the other recommended wall types.

Refer to the Appendix for sample calculations to determine the most cost-effective option.



WALL #4: SPLIT-INSULATED R-49 (EFFECTIVE)

(Insulation added to the exterior side)



① 3/4" Wood Siding

→ **First Weather Barrier**

② 3/4" Rainscreen Cavity

③ 1x3 Strapping

④ 8" Mineral Fibre Boards; 4@ 2"

→ **Insulation, R-33.5 (nominal)**

⑤ Self-Adhesive Membrane

→ **Second Weather Barrier + Vapour Barrier
+ Air Barrier**

⑥ 3/4" Plywood

⑦ 3 1/2" Mineral Fibre Batt

→ **Insulation, R-14 (nominal)**

⑧ 2x4 Wood Stud @ 16"

⑨ 1/2" Drywall - fibreglass-faced



The Self-Adhesive Membrane

The *Self-Adhesive Membrane (SAM)* functions very well as the **Second Weather Barrier**, the **Air Barrier**, and as a **Vapour Barrier**.

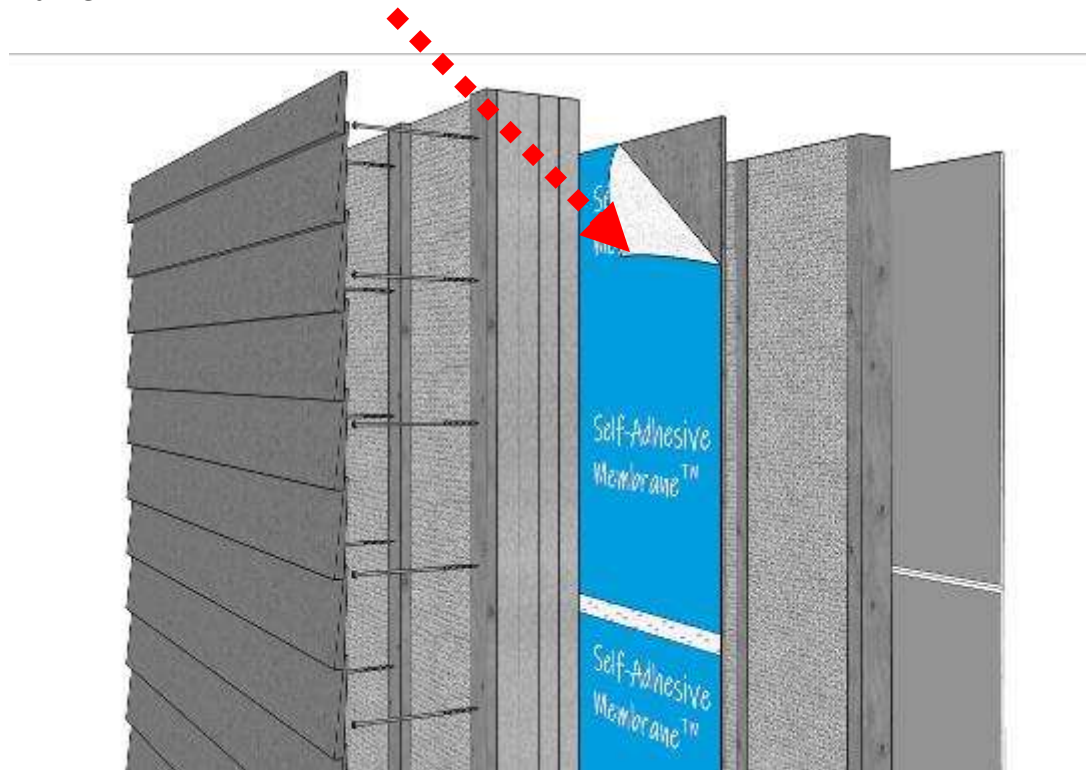

*Split-insulated wall with **Self-Adhesive Membrane (SAM)** highlighted*

Depending on how the wall is designed, the SAM must either be selected to act as a vapour barrier or not. The choice depends on the ratio of insulation on the interior side to the exterior side of the SAM. Since insulation reduces heat movement, the more insulation that is interior of the SAM, the lower the temperature of the SAM in colder weather. If too much insulation is on the interior side compared to the exterior side, the SAM can end up being below the dew point temperature of the interior air. This can result in condensation on the sheathing that supports the SAM.

Different sheet membranes have different vapour-permeance ratings. Some are considered vapour barriers and some are vapour “open.” Review the technical datasheets of the various SAM materials to help determine which to select, once the ratio of interior to exterior insulation is selected.

Remember that vapour barriers are materials that typically have a vapour permeance of $60 \text{ ng}/(\text{Pa}\cdot\text{m}^2\cdot\text{s})$ or less.



The Self-Adhesive Membrane

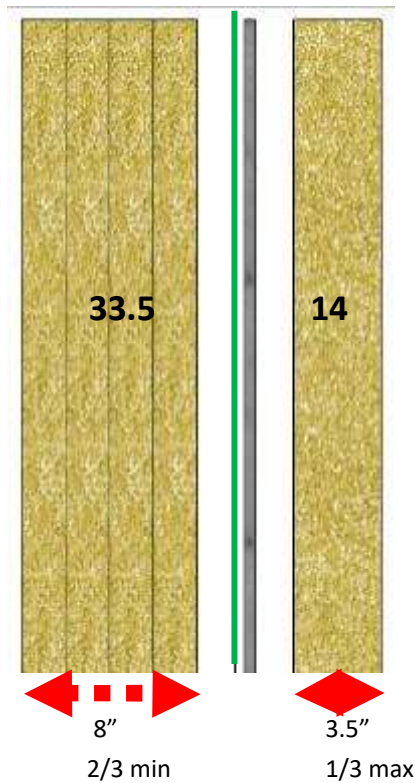

Split-insulated wall with the **Self-Adhesive Membrane (SAM)** in green

To minimize the risk of moisture issues, the majority of the insulation needs to be installed on the exterior side of the SAM. To avoid having too much insulation on the interior side, 2x4 studs with batt insulation are used for the wall instead of 2x6 studs. A safe rule of thumb is that at least 2/3 of the total nominal insulation should be on the exterior side of the vapour barrier, which is the SAM in this wall assembly. In other words: No more than 1/3 of the total nominal insulation should be installed on the interior side of the vapour barrier. In this example wall, the total *nominal* R-value is:

$$R33.5 + R14 = R47.5$$

The maximum safe amount of insulation is 1/3 the total nominal R-value:

$$\frac{1}{3} \times R47.5 = R15.8$$

This wall assembly uses R14 nominal batt insulation between the 2x4 studs. As this is less than 1/3 of the total insulation, the risk of moisture issues is low. It should be noted that if 2x6 studs with R24 batt insulation were used, too much insulation (i.e. greater than 1/3 total R-value) would be on the interior side of the SAM vapour barrier, and therefore any interior air or vapour that was able to get to the sheathing layer could condense into water.



The Insulation Layer

The eight inches of exterior insulation requires special-order, extra-long screws to attach the exterior strapping to the wall, through the multiple layers exterior insulation. The strapping, secured by 10” screws, holds the mineral fibre **boards** in place.

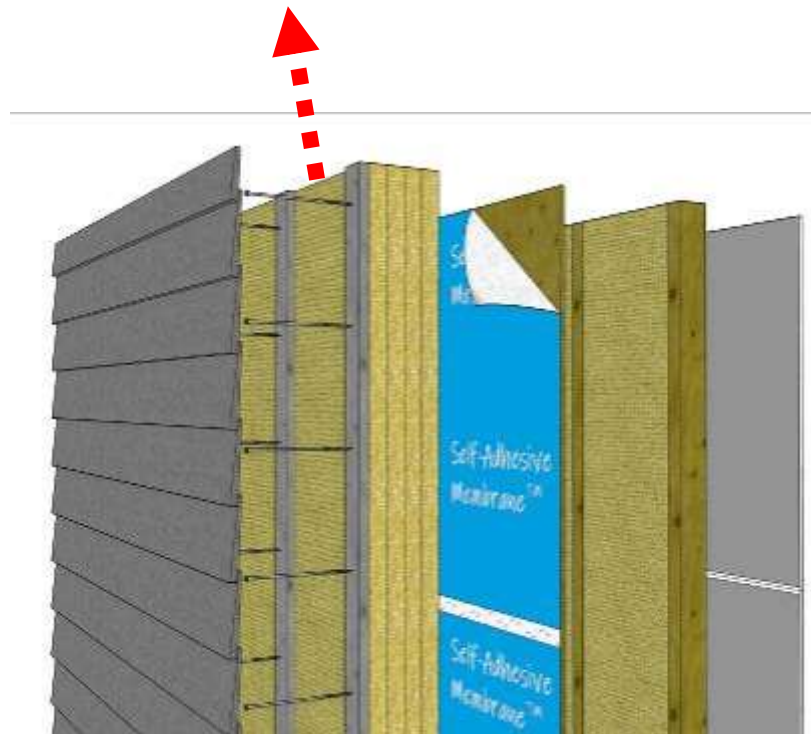

Extra-long screws used to attach the multiple layers of exterior insulation

Note that $\frac{3}{4}$ " plywood sheathing is used in this wall assembly. This provides an adequate bite for any screws that miss the studs.



Are there even higher insulation walls that may be considered?

As mentioned at the start of the walls section, there are other options for deeper, more insulative walls. Two of these wall types are super insulating approaches. If you want a wall with an effective R-value beyond R-50, this guide recommends using more exterior insulation on the triple-insulated wall. Other walls that can reach similar effective R-values are double wall or Larsen truss wall.

Double Walls: Some experienced passive-house builders use double walls. Builders who use this approach acknowledge the extra framed wall adds material cost. There are also theoretical concerns about moisture damage caused by air leaks contacting the cold exterior sheathing. Adding a Mooney wall-type service cavity to the interior to protect the poly air barrier, and covering the poly with ¼" OSB protection, can mitigate this risk. Using multiple air-seal layers with taped sheathing joints, or making the housewrap layer an additional air barrier, will further reduce this concern.

On the other hand, double walls can rely on less expensive batt insulation instead of more expensive exterior board insulation. It also tends to require less labour. It can be built flat on the floor, then tilted up. It doesn't require any additional work from the exterior, like approaches that require layers of board insulation on the exterior. Additionally, the second wall on the exterior makes window and door installation more conventional, and that lends itself to traditional platform framing.



Double-stud wall being tilted into place



Double-stud wall framing



Continued—Are there even higher insulation walls that may be considered?

Larsen Truss: Like the double wall, the Larsen truss emerged from super-insulated houses being built on the Prairies in the 1980s. The Larsen truss is a non-structural truss attached to the exterior of a conventional framed wall. It typically consists of a pair of 2x2s connected by intermittent plywood webs. A layer of plywood is then fastened to the outside edge of the truss. It can be labour-intensive to install, but offers the possibility of shop fabrication with less expensive small-dimension lumber.

The main benefit of the Larsen truss over the double-stud wall is that it covers the often poorly insulated rim joist area at the edge of floors. The covered floor edges are a benefit for houses with multiple stories.



Larsen truss viewed from the outside before insulation and plywood exterior are added



Continued—Any other walls to consider?

Wall types presented so far in this booklet offer the best performance, lowest cost and most efficient use of materials.

The following wall types are *not recommended* for northern communities.

Log: A simple log-cabin wall is a type of mass wall, and not recommended from a heat-loss perspective. Extremely large logs would be needed to achieve even the R-22 minimum effective R-value *National Building Code* requirement. Alternatively, insulation could be added to the log wall, but this defeats the aesthetic appeal of a log wall. Quarter-log siding could be installed to achieve the same look, and would cost much less.



A log house under construction



Continued—Any other walls to consider?

Basic Deep Stud – This wall uses 2x8 or deeper studs, and is not recommended. The cost of studs significantly increases with size (2x8 studs are about twice as expensive as 2x6 studs). More importantly, the benefit of the deep stud is lost due to thermal-bridging heat loss through the studs. A 2x6 stud wall with a 2 ½” service cavity costs less and performs better than a basic deep stud wall that uses 2x8 studs.

Deep Stud, Interior Insulated: This is a deep-stud wall with an insulation cavity added to the interior side. This approach addresses the thermal-bridging issue with the basic deep-stud wall and can easily achieve effective R-values greater than R-30. However, deep-stud framing is significantly more expensive than standard stud framing. A double stud wall offers a cheaper way to create a larger space for insulation.

Exterior Insulated: With this wall, all insulation is installed on the exterior side only. This makes sense for steel-framed walls. As the steel framing is such a strong thermal bridge, there is less benefit to adding insulation between the steel framing. Lots of heat would flow around the insulation through interruptions in the insulation. Designers put all the insulation on the exterior side of the steel framing so the framing does not bypass the insulation thermally. As wood framing is the preferred approach for houses in the north, this wall assembly is **not recommended**.

In wood-frame construction, adding insulation between the wood-stud framing is an easy and low-cost way to increase the effective R-value of your wall. From a heat-loss perspective, it is a waste of space to leave the stud cavity empty. It is recommended that mineral fibre batt insulation be installed between the wall’s wood studs.



Continued—Any other walls to consider?

Structural Insulated Panels (SIPs): Structural Insulated Panels (SIPs) are generally factory-made foam-core panels with either polystyrene or polyurethane foam adhered to two exterior wood-based panels, typically OSB. Metal Insulated Panels also exist and are available with additional types of insulation, such as mineral fibre and polyisocyanurate.



A piece of SIP with EPS foam insulation between two sheets of OSB

All SIPs are proprietary, in that there is no standard for these products and therefore they are not in building codes. Innovative non-standardized products that are not in building codes are evaluated by the Canadian Construction Materials Centre (CCMC) at the National Research Council (NRC) in Ottawa. The CCMC currently has SIPs evaluated and permitted for use that contain either one or two studs at panel ends. No-stud SIPs have not been evaluated. If SIPs are being considered, the engineer undertaking the house construction must have expertise in the use, attachment and long-term performance of the specific proprietary panels being used.

Airtightness depends on the fit between the panels. An accurately framed floor is critical to achieving this fit. In houses using the SIP approach, there have been notable cold-climate failures in Alaska, due to poorly sealed roof panels allowing interior humidity to damage the OSB. To be fair, there are also some 10-year-old examples of successful SIP houses in Nunavut, but those panels used plywood instead of OSB.



Continued—Any other walls to consider?

The construction of a house using SIPs is more specialized and complex, but does have some benefits over other wall approaches. This approach relies on significant pre-fabrication in a southern factory setting and is therefore relatively fast to erect on site, assuming the necessary hoisting equipment is available.

Consider a SIP approach to minimize the amount of installation labour required on site, and to construct a large number of houses quickly.

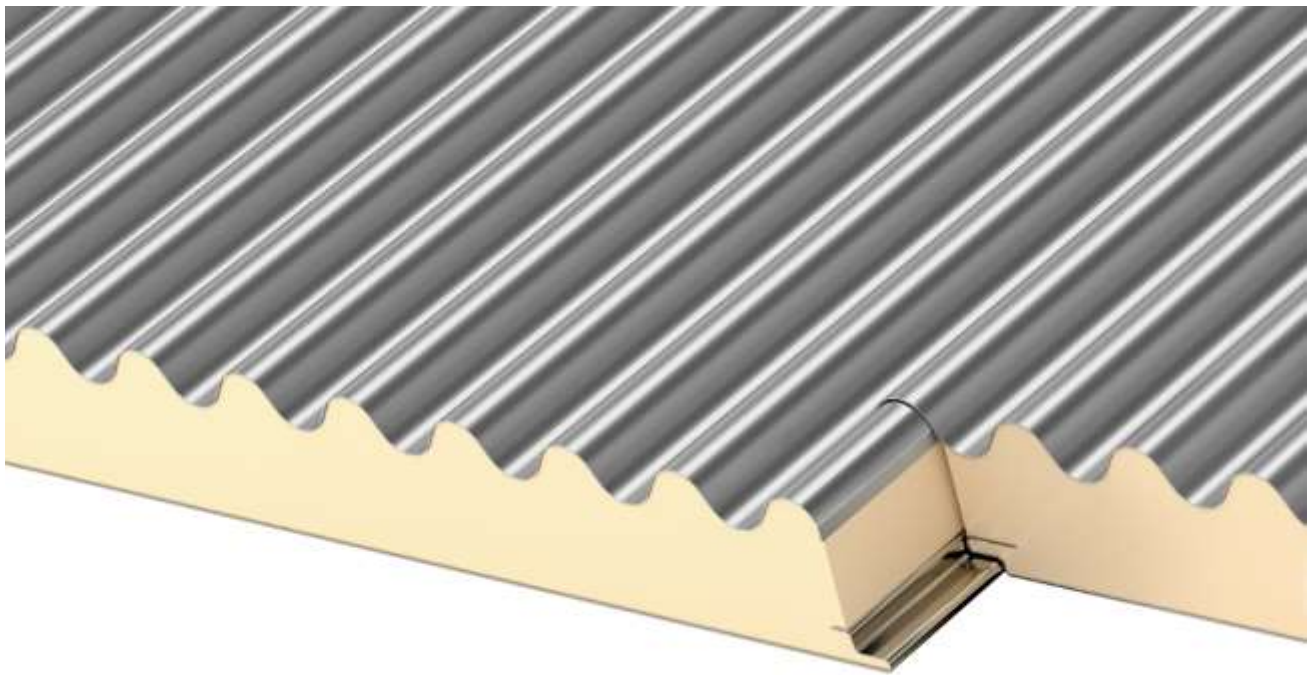

As the SIP manufacturer would be heavily involved in the planning and design of the houses, this guide does not discuss SIP options in detail. Contact a SIP manufacturer to find out more about SIP options.



A piece of SIP with foam insulation between two sheets of corrugated metal

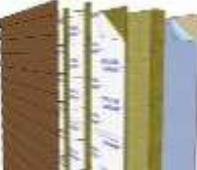
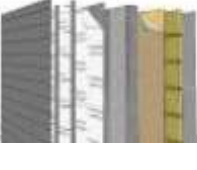
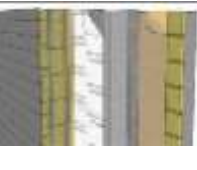

SUMMARY OF WALLS

PART 1: WALLS	(effective R-value)	Strengths
	<p>Wall # 1: The Traditional (R-23) (Basic 2x6 stud wall - <i>code-compliant version</i>)</p>	<ul style="list-style-type: none">• Lowest cost to construct• Well suited to houses heated by burning wood or another low-cost heat source
	<p>Wall #2: Mooney Wall (R-31) (Insulation added to the interior side)</p>	<ul style="list-style-type: none">• Lower cost to heat• Straightforward to construct• Air barrier is protected
	<p>Wall #3: Triple-Insulated (R-42) (Insulation added to the interior & exterior side)</p>	<ul style="list-style-type: none">• Very low cost to heat• Air barrier is protected• Uses common house-wrap that is straightforward and fast to install.
	<p>Wall #4: Split-Insulated (R-49) (Insulation added to the exterior side)</p>	<ul style="list-style-type: none">• Lowest risk of moisture issues• Lowest cost to heat



ROOFS



Steel standing-seam roofing panels being installed on a sloped roof. Note that the backup membrane is the full length under the steel roof.



Roof Selection: The recommended roof assemblies presented in this booklet

PART 2: ROOFS

(effective R-value)

page#

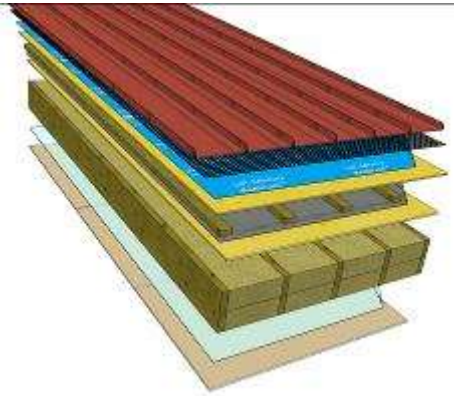

Roof #1: **The Traditional (R-43)**
(Basic 2x12 rafter roof)

69

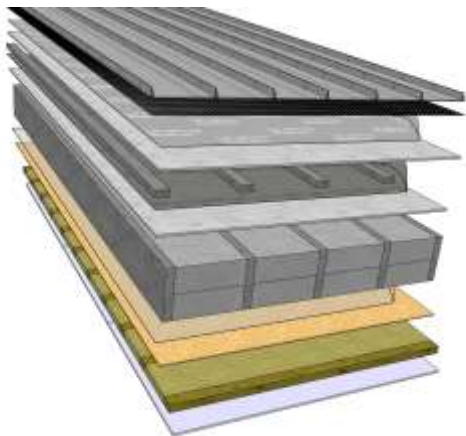

Roof #2: **Mooney Roof (R-51)**
(Insulation added to the **interior** side)

74

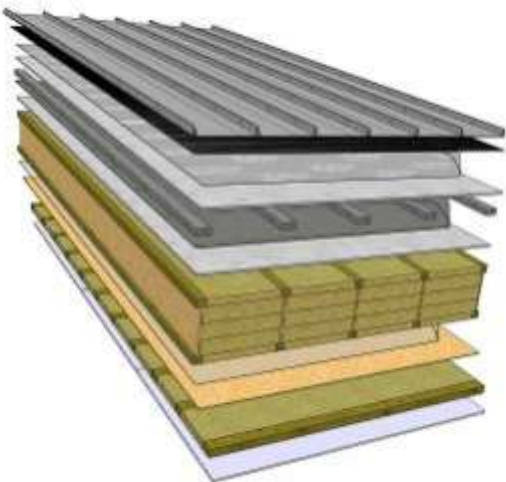

Roof #3: **I-Joist highly insulated roof (R-63)**

76



What are some options for roofs?

Roofs need to have the same environmental separation layers as walls. The differences are:

- The first and second weather barriers need to be waterproof or more water-resistant than on a wall.
- There is more space for batt insulation between structural members. Roof joists need to be deeper than wall studs for structural reasons.
- There is the option to pick a roof slope.
- There is the option to pick a vented attic or cathedral ceiling.
- Careful consideration of the airtight layer must be made so it can be connected to the wall airtight layers.

Two basic roofing configurations exist: sloped and flat. It makes sense to start with roof slope as the suitable roofing surfaces depend on what roof slope is being used. For example, shingles can't be installed on a flat roof.

 **Flat roofing** is poorly suited to remote northern housing.

- It is more challenging to temporarily patch/cover a roof leak on a flat roof.
- The amount of water leakage can be large with even a small defect or hole.

Flat roofs are generally mechanically drained; that is, with pipes, which are prone to freezing up. Drainage is typically concentrated at the end of a pipe that needs to discharge in a way that does not cause issues and is protected against freezing. This is very challenging in most northern communities.

 **Sloped roofing** is more appropriate for remote northern housing.

- It is more straightforward to temporarily patch a leak.
- A small defect in a sloped roof can be managed with relatively small amounts of water ingress, relative to a flat roof.



Continued—What are some options for roofs?

There are two overall approaches to sloped roofs: attic or cathedral ceiling.

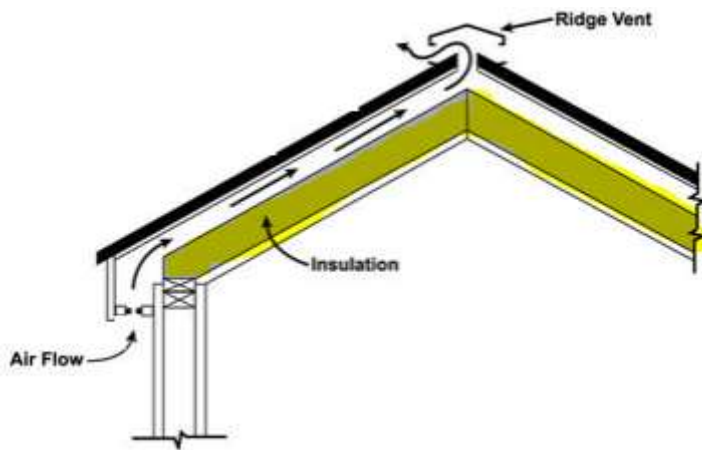

A roof with a cathedral ceiling

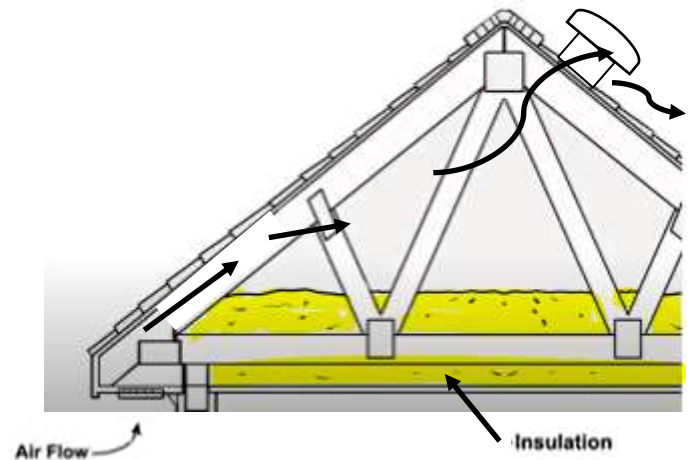

A roof with an attic

⚠ Attic roofs are the most common type of roof used in house construction in the urban areas of Canada. They have lots of room for insulation; low-cost, blown-in, loose insulation is ideal for attic roofs. However, the bulkiness of the trusses makes them expensive to ship and challenging to hoist into place. Also, modified venting of the attic is required to prevent windblown snow from entering the attic space if installed in the north.

✔ Cathedral roofs are recommended. They consist of joists, which are better suited to packing and shipping long distances, as well as lifting into place by hand, when a hoist/crane is not available.



Continued—What are some options for roofs?

- ✔ A **low slope** of about **3:12** or **4:12** is recommended. At slopes below 3:12, the roof starts to perform more like a flat roof (i.e. is not ideal for shingle or steel-panel roofing).

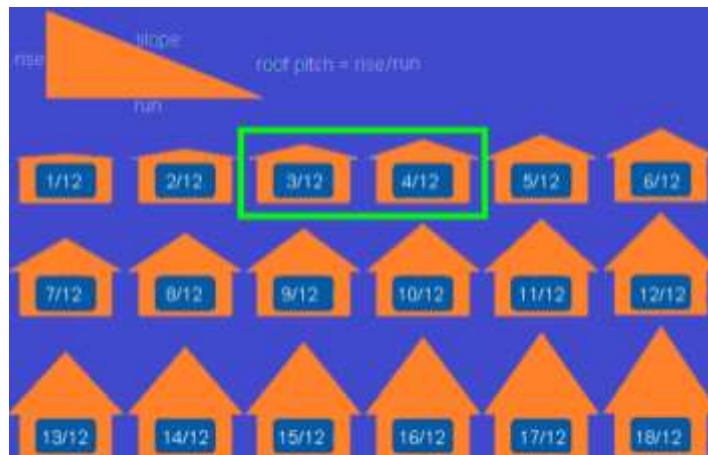

A wide range of roof slopes, with the recommended 3:12 and 4:12 highlighted in green box

- ⚠ **Steep roofs** with slopes greater than 4:12 are more challenging to install, maintain and repair. There is a greater risk of workers falling. Also, snowdrifts are more likely to form on the downwind side of the roof ridge, as the roof gets steeper. This can become a safety hazard when it slides.

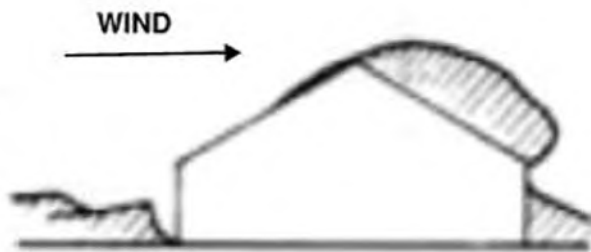

On more steeply sloped roofs, snow is prone to accumulating on the downwind side of the ridge.



Snow is easily blown off a low-slope roof; any snowdrifts are kept small.



How much insulation does my roof need?

The building code has minimum requirements for the effective R-value of a roof used in a house. Different minimum-effective R-values are listed based on climate zones. Northern Ontario is in the subarctic and arctic climate zones 7B & 8. The 7B and 8 climate zones corresponds to regions with 6,000 or more heating degree days (HDD).

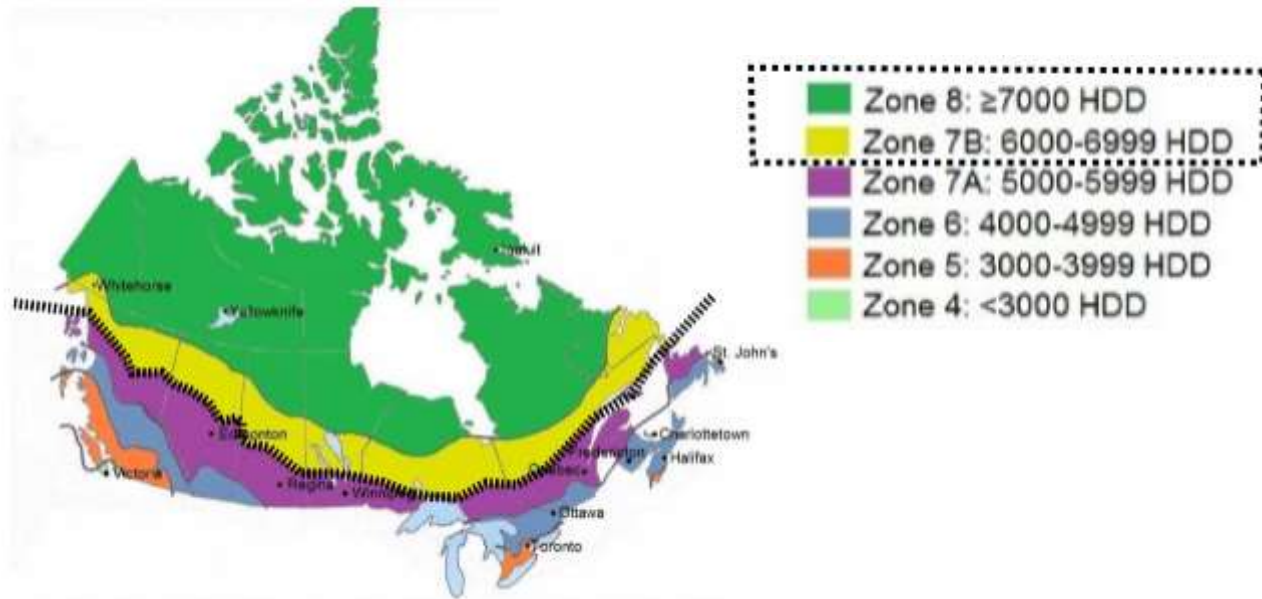

Map of climate zones based on heating degree days

(Zone 8 and 7B have the same minimum-effective R-value requirements.)

The National Building Code (2020) provides two minimums, one for houses with an attic space and the other for roofs without attic spaces (cathedral ceilings and flat roofs).

- Ceilings with attics: 10.43 RSI => R-59.2 (effective)
- Cathedral ceilings and flat roofs: 5.02 RSI => **R-28.5 (effective)**

***NOTE: The R-28.5 code minimum applies to cathedral ceilings and flat roofs only (the R-28.5 minimum can't be used for attics).**



Roofing Material Options

Roofing is the material used as cladding on the exterior surface of the roof. The roof is all of the materials that cover the top of the house and includes insulation and wood framing, drywall, and roofing materials.

There are lots of roofing options. For flat roofs, some common materials include EPDM, vinyl, TPO, and 2-ply modified bitumen membranes. All flat roofing products are much more common in commercial construction and generally require more skill and training to install properly than common materials for residential sloped roofing.

This guide recommends using a sloped roof. Options for sloped roofs include common asphalt shingles and steel-panel roofing. Other options for sloped roofs are poorly suited for the north, including:

- **Clay tiles:** excessively heavy and not freeze-thaw resistant
- **Concrete tile:** excessively heavy
- **Slate (stone) tiles:** excessively heavy
- **Wood shakes or shingles:** better suited for roofs steeper than 4:12 and more expensive than asphalt shingles, but service life is similar to asphalt shingles.

Asphalt-shingle and prefinished steel-panel roofing are the two most common roofing materials, with an established history of widespread use in the north. Both options are straightforward to install and repair.

One big advantage of asphalt-shingle roofing over steel is that snow does not easily slide off low-slope asphalt-shingle roofing. With a steel panel roof, sliding snow can be a safety hazard, especially if a door is located at the bottom of a roof slope.

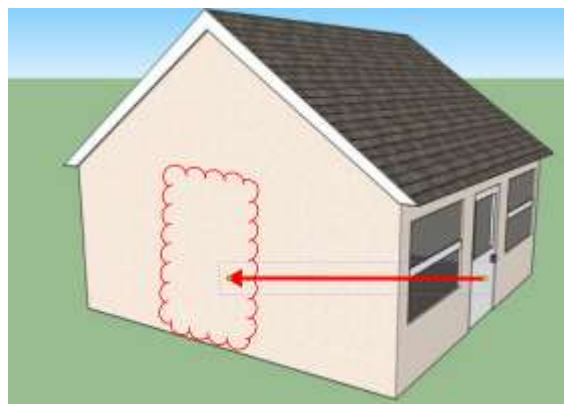

Door at bottom of roof slope with arrow pointing to a safer location, especially if roof is steel



Continued—Roofing options

There are two general types of steel-panel roofing: **Exposed-fastener** and **concealed-fastener**.

Exposed-fastener roofing is prone to early failure. The steel panels expand and contract with the large temperature variations between summer and winter. This expansion and contraction causes the holes around the fasteners to get larger and oval-shaped. The rubber gaskets between the panel and the fastener head also have relatively short lifespans. For these reasons, asphalt-shingle roofs generally can last longer than exposed-fastener steel-panel roofs before leakage occurs.



*Exposed-fastener metal roofing
(lots of fastener holes through the roof)*

The fasteners need to be concealed to make prefinished metal roofing last longer than a common asphalt-shingle roof. Preformed standing-seam steel panels are straightforward to install. They have a concealed fastener flange that gets covered by the panel next to it and the seams snap together.

Note: Silicon modified polyester (SMP) paint coatings are the most common and cheapest for steel roofing, but a polyvinylidene fluoride (PVDF) paint coating will last longer and help extend the life of steel panels.

- ✔ Use preformed standing-seam steel roofing panels with snap-lock seams and fastener flange for concealed fasteners with a polyvinylidene fluoride (PVDF) paint coating.

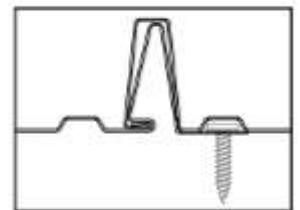
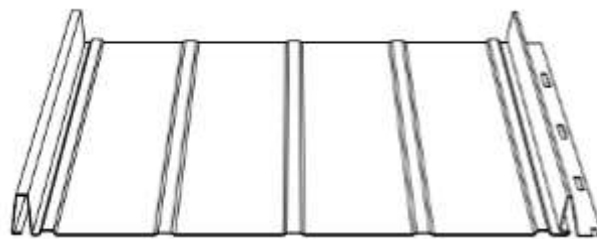

Preformed standing-seam steel roofing with snap-lock seams and fastener flange for concealed fasteners



Continued—Roofing options

In general, asphalt-shingle material degrades faster than prefinished steel panels, and is combustible. A house with an asphalt-shingle roof is more likely to ignite from a nearby fire than a house with steel-panel roofing. Asphalt shingles are economical and straightforward to install/repair, making it the most common roofing for residential housing. Asphalt shingles can work well for communities where the risk of fire is relatively low.

⚠ Historically, the most commonly used asphalt shingle was a three-tab asphalt shingle *made with organic felt* (heavy paper). These shingles have relatively short service lives and deteriorate quickly on surfaces with lots of direct sun exposure. They are also susceptible to wind damage.

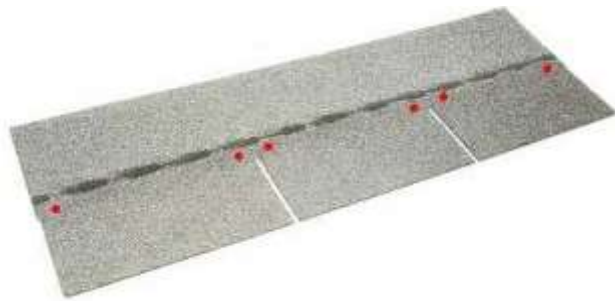

A typical three-tab asphalt shingle



Weathered, sun-damaged roof (three-tab asphalt shingle with organic felt)

Asphalt shingles made with a *woven fibreglass* base mat and consisting of multiple laminated layers are thicker and last longer than 3-tab *organic felt* shingles. These longer-lasting shingles are called architectural shingles.

✓ **Architectural woven fibreglass shingles are recommended over 3-tab shingles.**



Two architectural shingles



ROOF #1—THE TRADITIONAL ROOF

The traditional roof is built with 2x12 rafters, batt insulation between rafters, and a cathedral ceiling. It is the cheapest and simplest roof to construct of the recommended roof types.

The traditional roof is best for communities that have an abundant supply of low-cost firewood for heating or another source of low-cost energy.



ROOF #1: The Traditional **R-43 (EFFECTIVE)**

(Basic 2x12 rafter roof)

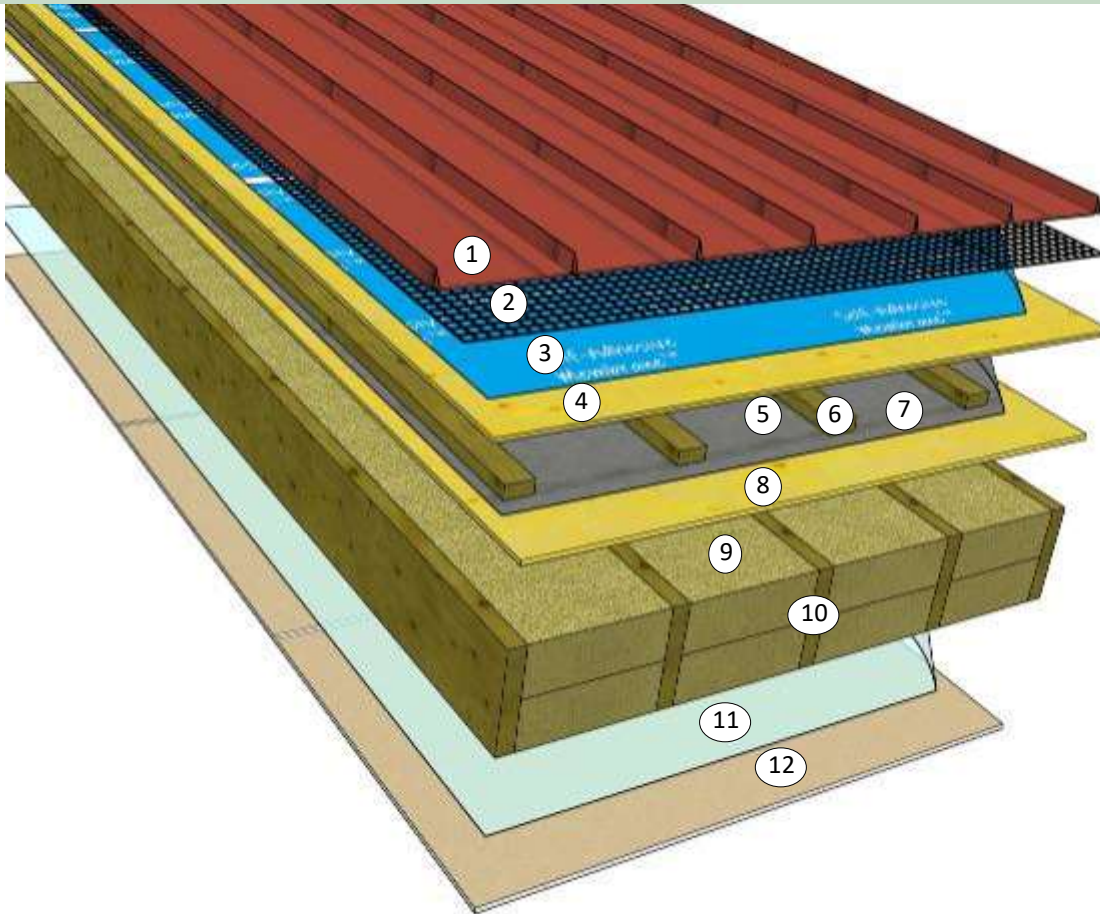

① Concealed Fastener, Preformed Standing-
Seam Steel Roofing

→ **First Weather Barrier**

② 10mm woven mesh

③ Self-Adhesive Membrane

→ **Second Weather Barrier**

④ ½" Plywood

⑤ 1½" vent space

⑥ 2x3 on flat

⑦ Roofing Underlayment

→ **3rd Weather Barrier**

⑧ ½" Plywood

→ **Air Barrier**

⑨ 11" Mineral Fibre Batt; 2 @ 5 ½"

→ **Insulation, R-48 (nominal)**

⑩ 3:12 Slope 2x12 wood rafter @ 16"

⑪ 6-mil polyethylene

→ **Vapour Barrier + Air Barrier**

⑫ ½" drywall - fibreglass-faced



Multiple Roofing Layers

The most common roofing is asphalt shingles with an underlayment installed over the plywood or OSB roof sheathing. The asphalt shingles are the first barrier against weather and the underlay is the second. This very common approach to roofing usually has a service life of about 10 to 25 years. The short 10-25-year service life is a disposable approach to roofing where a house that lasts 50 years could easily need its roofing replaced two or three times. This is especially bad for the north, given the high cost of shipping and landfill waste-management issues. The recurring need to replace roofing with a short lifespan also diverts the limited supply of local labour away from building new housing or other important housing projects. Ideally, the roofing should last as long as the house, or as long as possible. This is the intent of the recommended roof with multiple roofing layers.

✔ **Additional roofing layers are recommended to help the roof last much longer.**

Preformed standing-seam steel roofing panels, with snap-lock seams and fastener flange for concealed fasteners with a polyvinylidene fluoride (PVDF) paint coating, are recommended for their long service life.

- **Woven mesh** is recommended so that any moisture that gets under the steel roofing is able to easily dissipate. It also functions as a slip sheet to reduce friction from expansion and contraction.
- **Self-adhered membrane (SAM)** is waterproof, and recommended over typical water-resistant underlays.
- The **second layer of plywood sheathing** above the vent space is needed to support the steel-panel roofing.
- The **1½" vent space** is recommended to let any moisture that gets under the roofing layers dissipate. It also helps keep the roof surface cold and minimizes ice-damming risk.
- The **roofing underlay** under the vent space is a third barrier against weather. It protects the plywood and insulation below from small amounts of moisture that may enter the vent space.

⚠ **Note:** It will be tempting to delete the vent space, the second layer of plywood, and the third weather barrier to reduce construction cost. This is a valid approach to roofing, but is also higher risk. If the batt insulation gets wet, it will not be able to dry out toward the exterior into the vent space. With this lower-cost variation of the recommended roof, the lifespan may be shortened if there is leakage or condensation. It is also likely to be more expensive from a lifecycle perspective.



The Insulation Layer

All the required insulation can easily fit in the space between the roof rafters. The minimum effective R-value is R-28.5 for a roof with a cathedral ceiling. The traditional roof achieves R-43 effective with mineral fibre batt insulation installed between the 2x12 rafters.

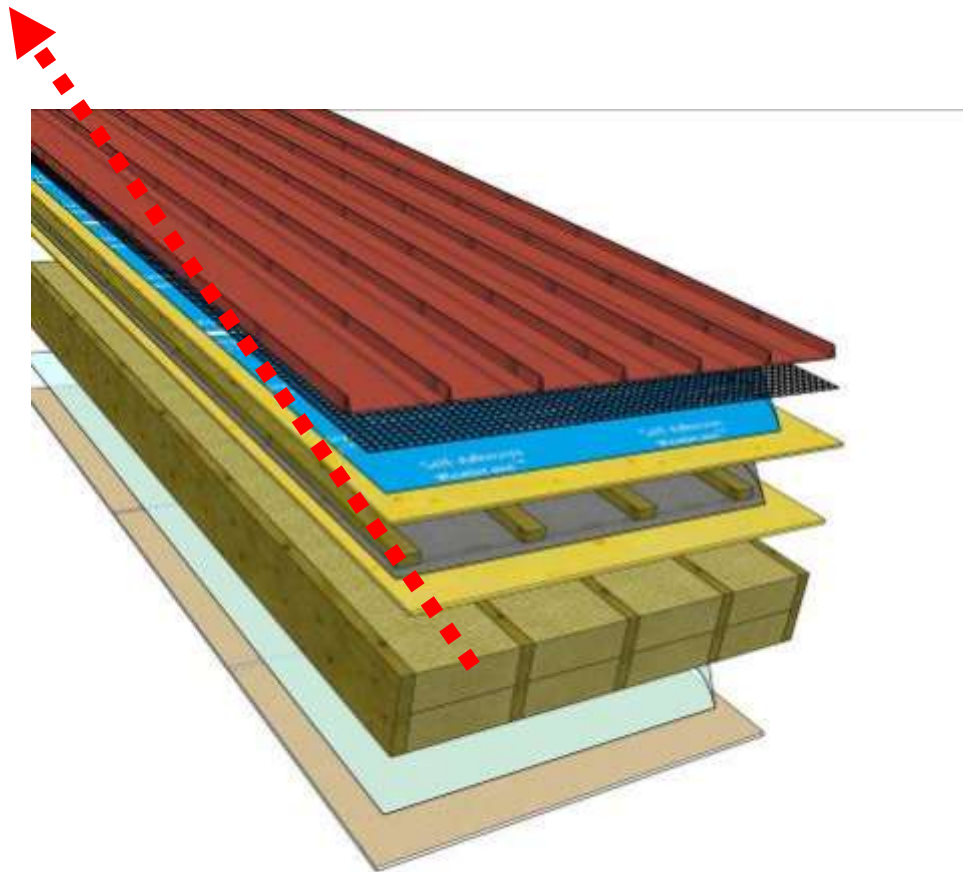

The traditional roof with the insulation layer highlighted



The Air-Barrier Layer

Similar to the traditional wall, the 6-mil poly is the vapour barrier and part of the air-barrier system. Tape and acoustical sealant to make the 6-mil poly airtight are other components of the air-barrier system.

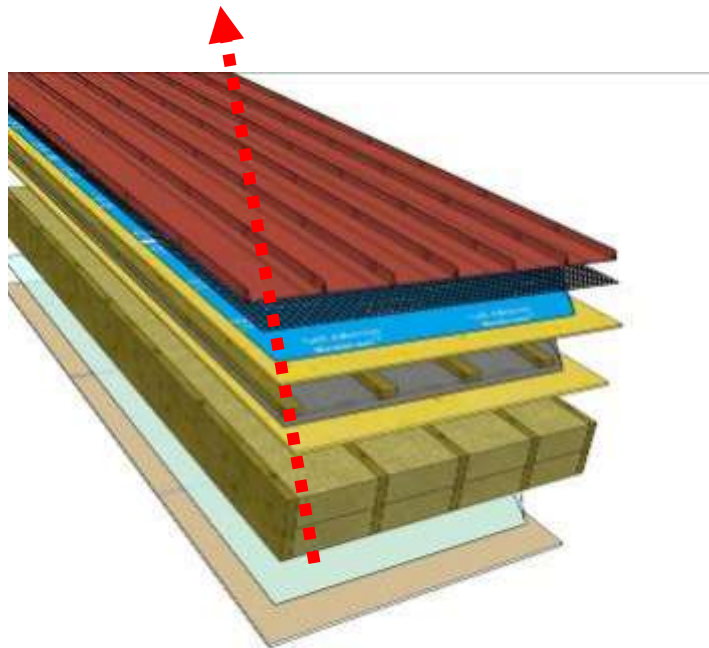

Traditional roof with 6-mil poly highlighted

It is recommended that the layer of plywood be installed as an additional air-barrier layer, by taping the joints. This will reduce the risk of moisture issues caused by air leakage.

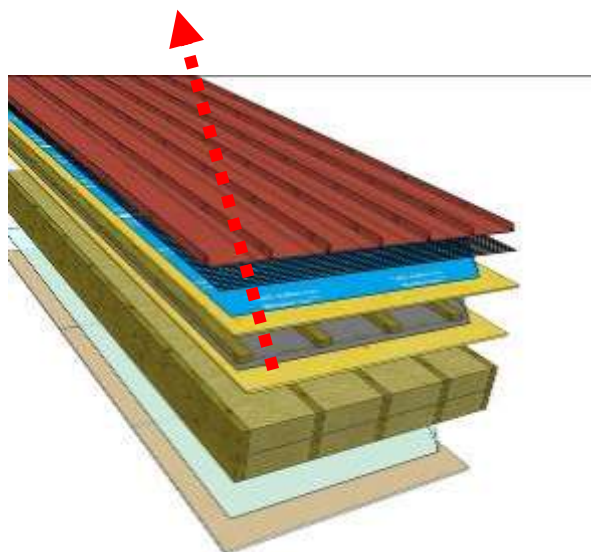

Traditional roof with the bottom layer of plywood highlighted



ROOF #2—MOONEY ROOF

The Mooney roof is a traditional roof with insulation added to the interior side. It has a high effective R-value, and the 6-mil poly air-barrier layer is more protected than in the traditional roof.



MOONEY ROOF WITH 2X3 SERVICE CAVITY R-51 (EFFECTIVE)

(Insulation added to the interior side)

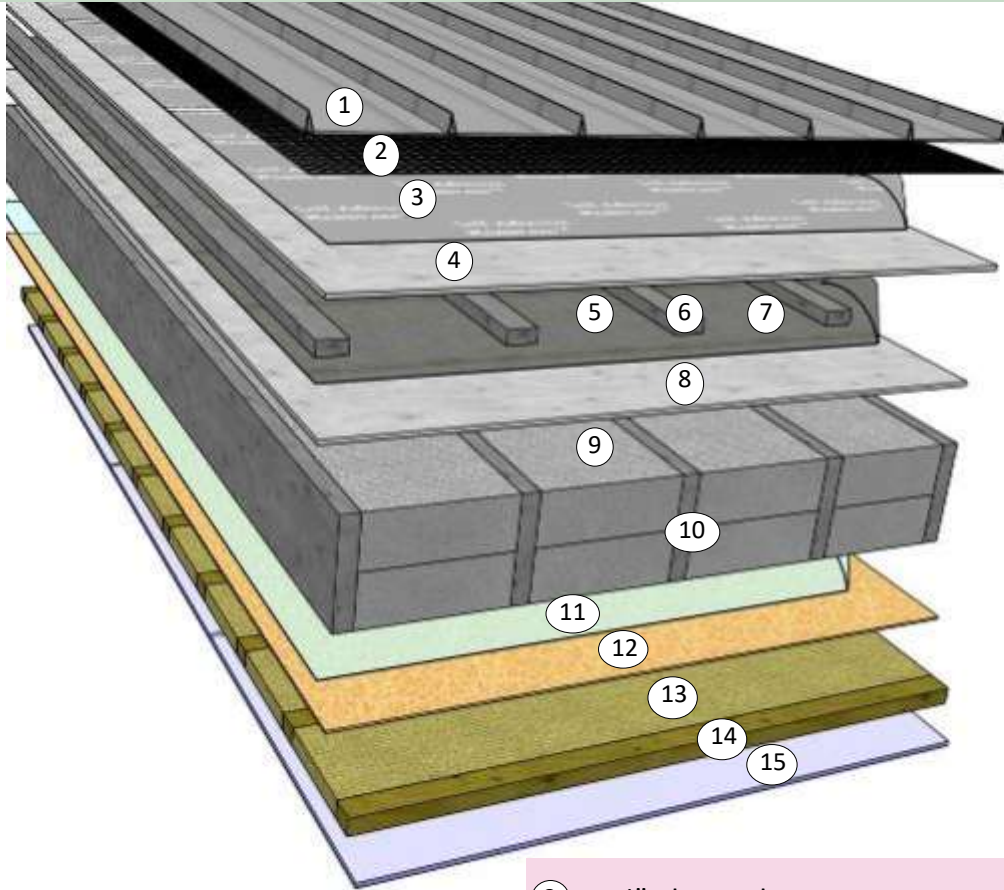

① Concealed Fastener, Preformed Standing-Seam Steel Roofing

→ **First Weather Barrier**

② 10 mm woven mesh (cedar breather)

③ Self-Adhesive Membrane

→ **Second Weather Barrier**

④ ½" plywood

⑤ 1½" vent space

⑥ 2x3 on flat

⑦ Roofing Underlayment

→ **Third Weather Barrier**

⑧ ½" Plywood

→ **Air Barrier**

⑨ 11" Mineral Fibre Batt; 2 @ 5 ½"

→ **Insulation, R-48 (nominal)**

⑩ 3:12 Slope 2x12 rafters @ 16"

⑪ 6-mil polyethylene

→ **Vapour Barrier + Air Barrier**

⑫ ¼" OSB

⑬ 2 ½" compressed mineral fibre batt; 1@3 ½"

→ **insulation, R-10 (nominal)**

⑭ 2x3 wood stud, horizontally @ 16"

⑮ ½" drywall - fibreglass-faced



ROOF #3—I-JOIST HIGHLY INSULATED ROOF

The I-joint highly insulated roof is a Mooney roof that has deeper I-joint rafters instead of 2x12 lumber. It has a very high effective R-value for a roof with a cathedral ceiling. With an effective R-value of R-63, it is comparable to an attic roof for resistance to heat loss.

The deeper I-joint rafters will also allow for larger spaces between walls, as the I-joists are structurally stronger and can span longer distances.



I-JOIST HIGHLY INSULATED ROOF WITH 2X3 SERVICE CAVITY - R-63 (EFFECTIVE)

(16" I-joist rafters & insulation added to the interior side)

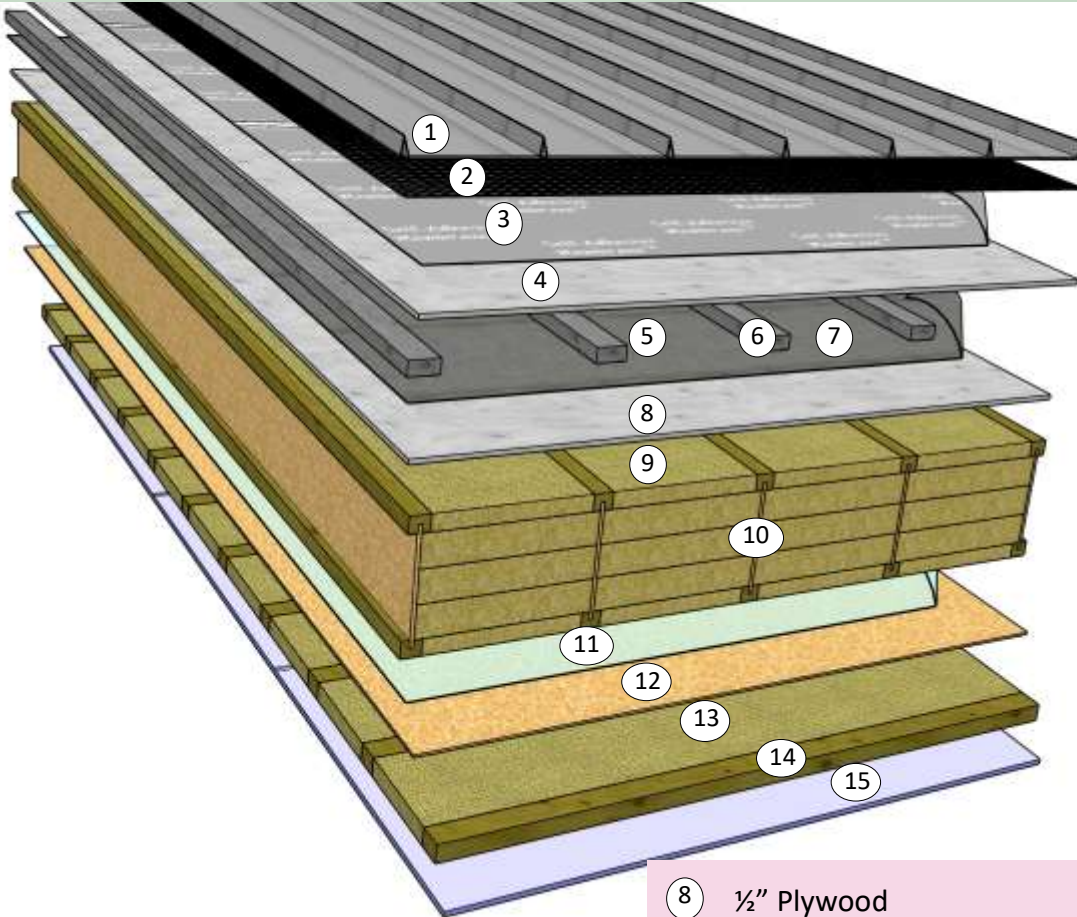

① Concealed Fastener, Preformed Standing-Seam Steel Roofing

→ **First Weather Barrier**

② $\frac{3}{8}$ " (10mm) woven mesh (cedar breather)

③ Self-Adhesive Membrane

→ **Second Weather Barrier**

④ $\frac{1}{2}$ " Plywood

⑤ $1\frac{1}{2}$ " vent space

⑥ 2x3 on flat

⑦ Roofing underlayment

→ **Third Weather Barrier**

⑧ $\frac{1}{2}$ " Plywood

→ **Air Barrier**

⑨ 16" mineral fibre batt; 1x5 $\frac{1}{2}$ ", 3x3 $\frac{1}{2}$ "

→ **insulation, R-66 (nominal)**

⑩ 16" deep I-Joists @ 16" o/c

⑪ 6-mil polyethylene

→ **Vapour Barrier + Air Barrier**

⑫ $\frac{1}{4}$ " OSB

⑬ 2 $\frac{1}{2}$ " compressed mineral fibre batt; 1x3 $\frac{1}{2}$ "

→ **insulation, R-11 (nominal)**

⑭ 2x3 wood stud, horizontally @ 16"

⑮ $\frac{1}{2}$ " drywall - fibreglass-faced



The Insulation Layer

The 16” deep I-joists create a large space for lots of batt insulation.

I-joists increase the space available for insulation. Another key advantage of I-joists is their relatively thin webs. Compared to sawn lumber, the webs also decrease thermal bridging.

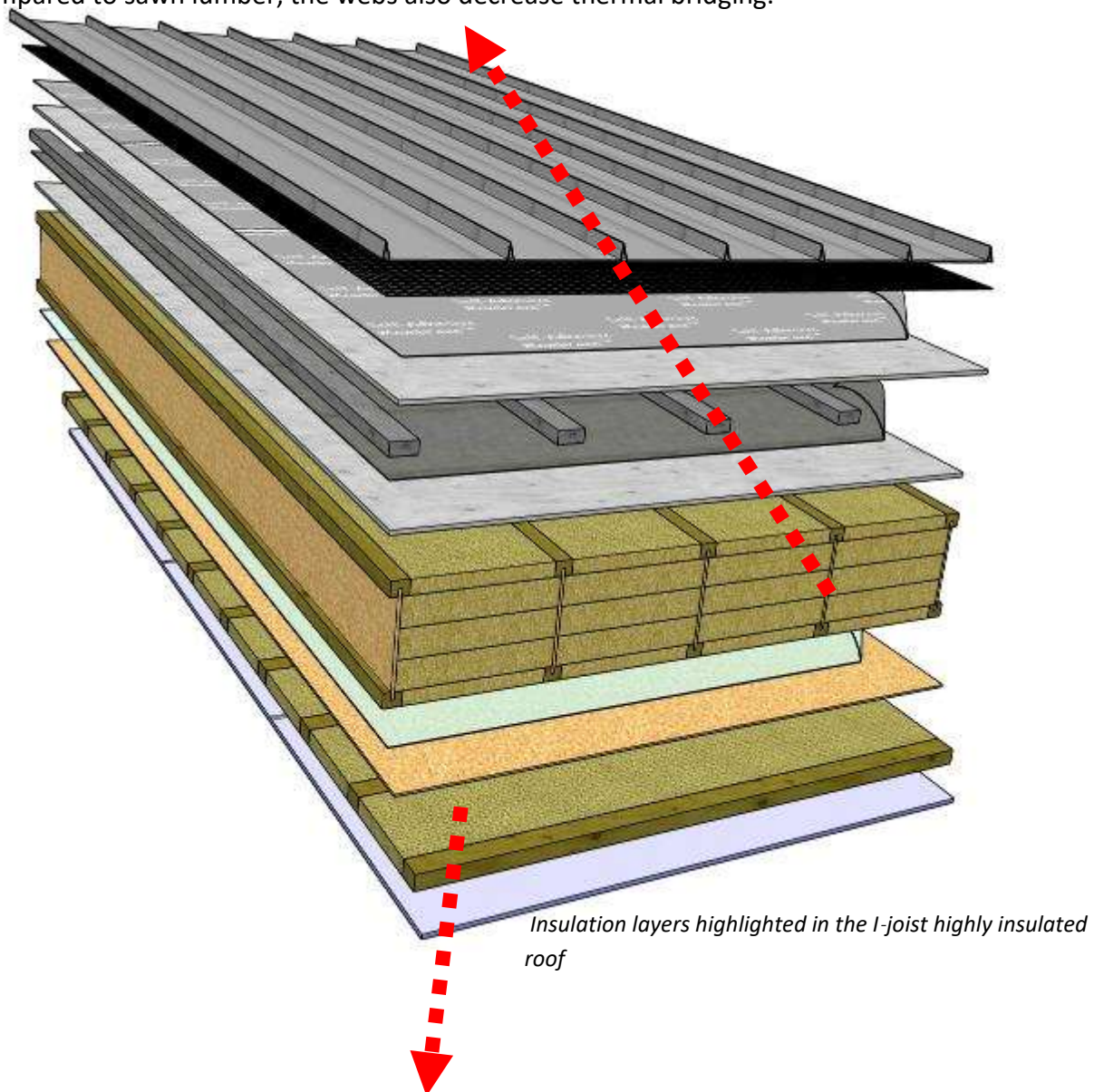

The effective R-value of the roof is also increased by adding a 2 ½” service cavity to the basic wall and filling it with insulation. The 2x3 stud framing runs across the I-joists. The insulation in the service cavity reduces the already low heat loss bridging through the I-joists.



SUMMARY OF ROOFS

PART 2: Roofs

(effective R-value)

Strengths

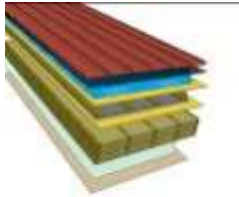

Roof # 1: **The Traditional Roof**
(Basic 2x12 rafter roof)

(**R-43**)

- Lowest cost to construct
- Well suited to houses heated by burning wood or another low-cost heat source.



Roof #2: **Mooney Roof**
(Insulation added to the interior side)

(**R-51**)

- Lower cost to heat
- Straightforward to construct
- Air barrier is protected



Roof #3: **I-Joist Highly Insulated Roof** (**R-63**)

- Lowest cost to heat
- Straightforward to construct
- Air barrier is protected



FLOORS



Wood-floor framing being constructed on a space frame foundation



Floor Selection: The recommended floor assemblies presented in this booklet

PART 3: FLOORS (effective R-value) page#



Floor #1: **The Traditional** (R-40) 90
(Basic 2x12 joist floor)

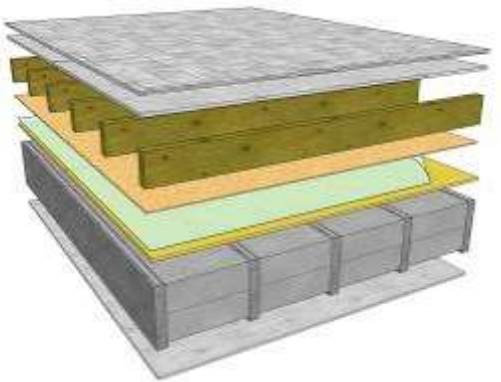

Floor #2: **The Traditional Hot-Floor Version** (R-42) 94

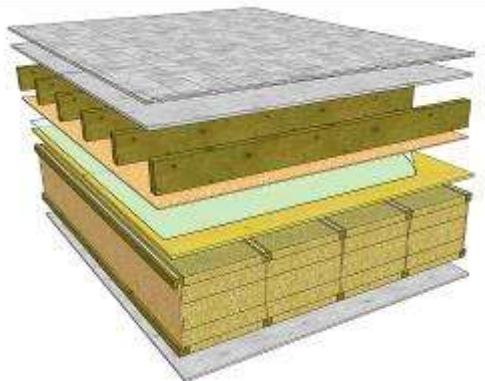

Floor #3: **I-Joist Hot-Floor Version** (R-62) 97



What are some options for floors?

At the most basic level, there are three types of floors: above-grade, on-grade, and below-grade. Above-grade floors are generally the most practical approach for houses in the north. A basement with a below-grade floor in a permafrost region would be very high risk for settlement issues, due to permafrost thawing. An on-grade floor would also be prone to settlement issues and is not adjustable. For these reasons, only above-grade floors are recommended.

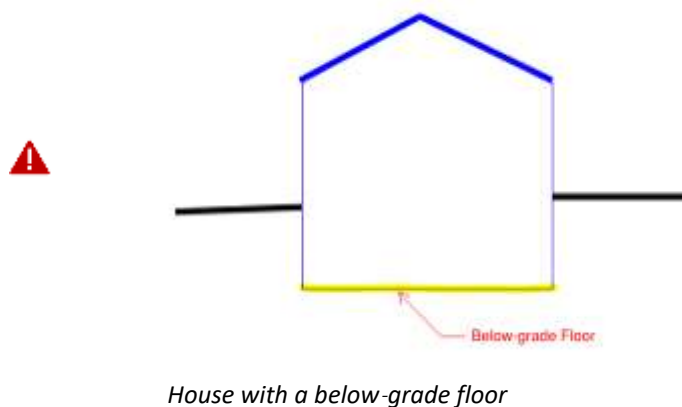
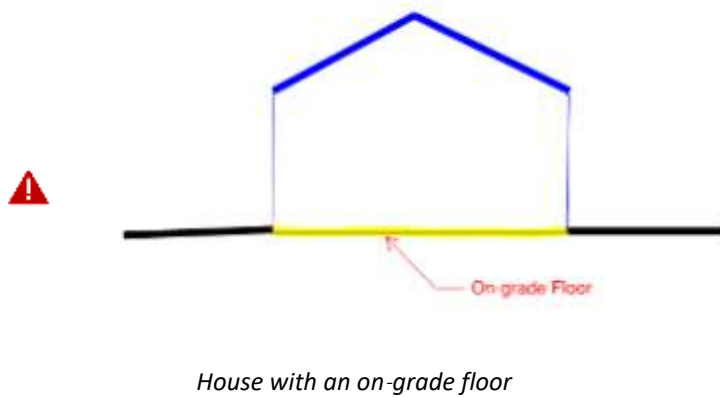
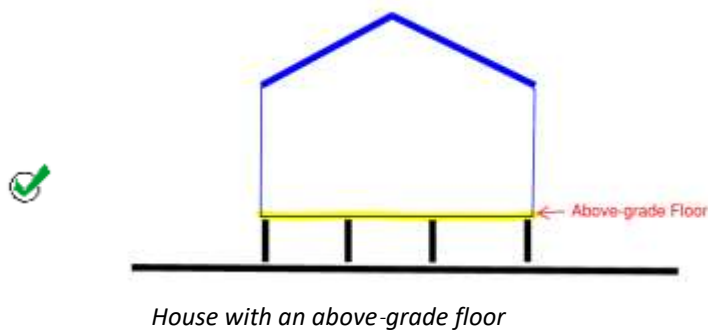



Cold Floors and Hot Floors

The most basic floor has insulation installed between the floor joists, and the flooring surface installed directly on top. This traditional type of interior floor surface is prone to being cold. A mattress or pile of clothes can freeze to the floor by blocking the heat in the room from reaching the flooring surface. For this reason, this is referred to as a cold-floor assembly. Experience has shown that adding more insulation to a cold floor does *not* reliably address the issue.

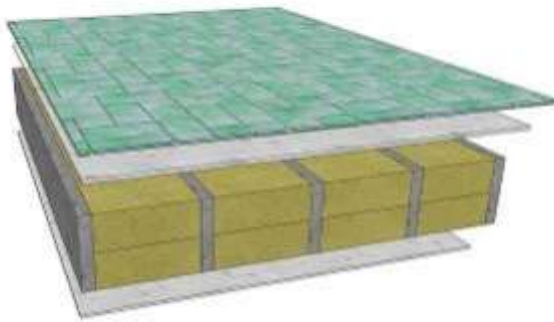

A basic cold floor with insulation between joists and the interior flooring installed directly on top

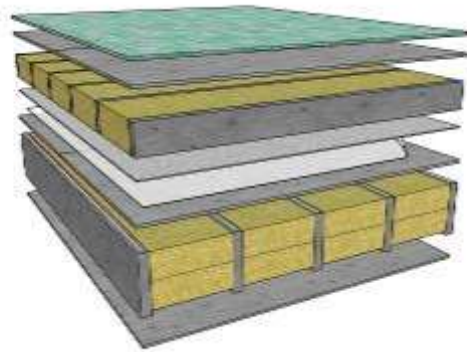

A cold floor with an added layer of insulation and interior flooring installed directly on top

A practical way to keep the interior flooring finish warm is to let the warm air in the room flow underneath the flooring surface. This can easily be achieved by installing an uninsulated space under the flooring so that the warm air in the room can warm the floor from both sides. A few openings/air vents are needed to allow air in the room to mix with air under the flooring. This space under the flooring is also very useful for air ducts and water pipes.

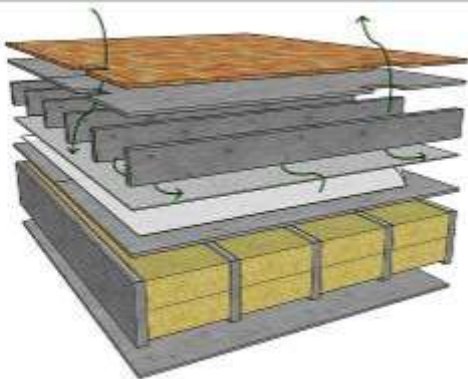

A hot floor with a service cavity under the interior flooring finish that is open to air in the room



A hot-floor construction in progress with air ducting installed in the service cavity before the flooring is installed over top



How much insulation does my floor need?

The building code has minimum requirements for the *effective* R-value of a floor used in a house. Different minimum *effective* R-values are listed based on climate zones. Northern Ontario is in the subarctic and arctic climate zones: 7B and 8. The 7B & 8 climate zones correspond to regions with 6,000 or more heating-degree days (HDD).

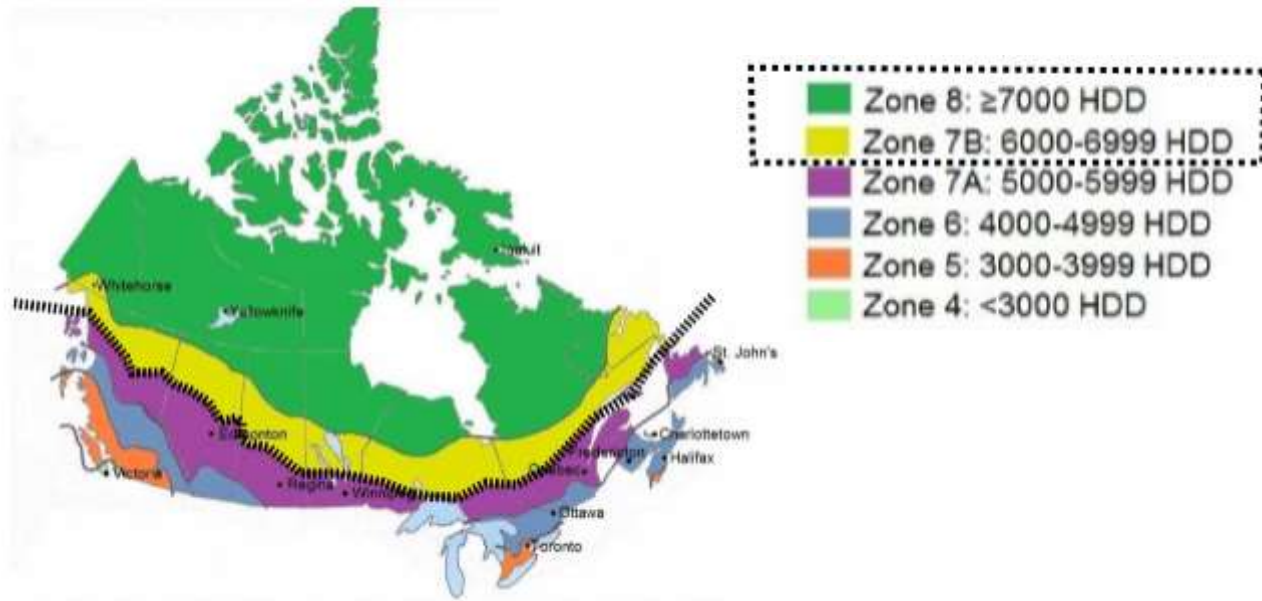

Map of climate zones based on heating-degree days

(Zone 8 and 7B have the same minimum *effective* R-value requirements.)

The National Building Code (2020) identifies above-grade floors as floors over unheated spaces, and specifies a minimum *effective* R-value.

- Floors over unheated spaces: 5.02 RSI = > **R-28.5 (effective)**



Flooring Options

Flooring is the interior finish or surface that people walk on. Carpet is a type of flooring. The floor is the complete assembly of environmental separation layers, including the insulation, wood joists and flooring. The ideal flooring material for a house in the north needs to be:

- flexible to tolerate some foundation movement
- moisture-tolerant
- durable and resistant to wear
- not excessively heavy to ship
- low-maintenance and easy to clean

Common flooring materials are listed in this booklet. Only some of them are appropriate for the north.

Carpet: (not recommended)

- easily soiled and stained
- high-maintenance to clean (vacuum and carpet cleaner)
- collects dust, reducing air quality
- mould growth from wetting
- warm and soft to touch; most comfortable for bare feet
- reduces sounds
- flexible to tolerate some foundation movement



Carpet is easily soiled by spills that are difficult to remove.



A vacuum and carpet cleaner are needed to properly clean a carpet.



Continued—Flooring Options

Ceramic Tile: (not recommended)

- excessively heavy to ship
- not flexible, and prone to cracking with foundation movements
- moisture-tolerant
- durable and resistant to wear



Ceramic tile being installed

Solid wood (hardwood), engineered wood, and laminate flooring: (not recommended)

- moisture-sensitive
- easy to clean



Water-damaged laminate flooring



LAMINATE

SOLID

ENGINEERED

Laminate flooring has a particle-wood core. Hardwood or solid wood flooring consists of a traditional plank of solid wood; engineered wood consists of multiple layers of solid wood and plywood.



Continued—Flooring Options

- ✔ **Painted plywood:** suitable for utility or storage rooms.
- low cost
 - straightforward to install and repair
 - low-maintenance and easy to clean



Painting a plywood floor: prime paint coat (white), enamel paint coat (beige), polyurethane finish coat (clear)

- ✔ **Linoleum sheet:** 2.5 mm-thick sheet flooring is recommended, except for high-traffic areas.
- made from natural/organic materials that naturally break down
 - flexible to tolerate foundation movements
 - moisture tolerant
 - not excessively heavy to ship
 - low-maintenance and easy to clean



Sheet linoleum



Liquid linoleum



Continued—Flooring Options

✔ **Vinyl sheet:** recommended; slightly more durable than linoleum.

- a synthetic material that does not easily break down
- flexible to tolerate foundation movements
- moisture-tolerant
- not excessively heavy to ship
- low-maintenance and easy to clean



Vinyl-sheet flooring being installed

✔ **Vinyl tile or plank:** recommended

- more durable than sheet vinyl
- easier to repair than sheet products
- requires effort to keep joints clean



Vinyl-tile flooring being installed



Continued—Flooring Options

✔ **Rubber Sheet:** A thickness of 1.8 to 2.5 mm is recommended.

- most durable
- most water-tolerant
- non-slip
- flexible to tolerate some foundation movement
- not excessively heavy to ship
- low-maintenance and easy to clean



Sheet-rubber flooring is waterproof.



Sheet-rubber flooring rolls

Summary of recommended flooring materials:

Rubber sheet flooring: The most durable and waterproof option. Ideal for high-traffic and wet areas, such as entrance vestibules (1.8 to 2.5 mm-thick sheeting is recommended).

Vinyl-tile or plank flooring: The next most durable option and easy to repair.

Vinyl-sheet flooring: Slightly more durable than linoleum, but a synthetic material that does not easily break down in a landfill.

Linoleum-sheet flooring: An ideal flooring material for the north, except for high-traffic or very wet areas. It is made of natural/organic materials and will naturally break down in a landfill. Linoleum is the best option from an environmental perspective.

Painted plywood flooring: Well suited for utility rooms and storage areas.



FLOOR #1—THE TRADITIONAL

The traditional above-grade floor consists of wood-floor joists, with all insulation installed between the joists. It is the lowest cost and simplest floor to construct of the recommended floor types, and the most common type of raised floor.

The traditional floor is best for communities that have an abundant supply of low-cost firewood for heating, or another source of low-cost energy.



THE TRADITIONAL 2X12 FLOOR R-40 (EFFECTIVE)

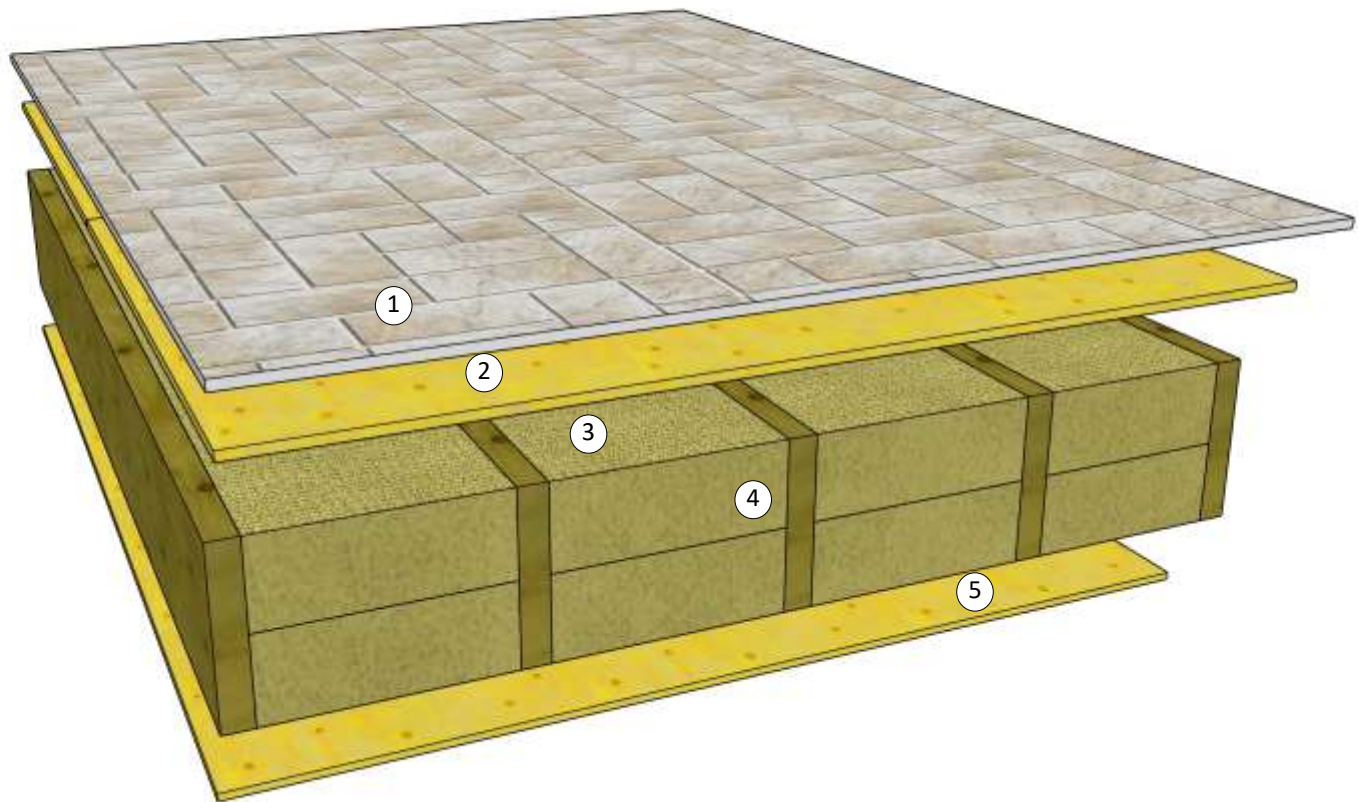

- ① Linoleum-sheet flooring
→ **Vapour Barrier**
- ② 5/8" T & G Plywood (with sealed joints)
→ **Air Barrier**
- ③ 11" **Mineral Fibre Batt**; 2 @ 5 1/2"
→ **Insulation, R-48 (nominal)**

- ④ 2x12 Floor Joists @ 16" O/C
- ⑤ 1/2" plywood
→ **Insulation cover**



The Insulation Layer

The 2x12" joists easily accommodate 11" of mineral fibre batt insulation with a nominal R-value of R-48. The corresponding effective R-value is R-40, well above the R-28.5 effective minimum required by code.

The Vapour Barrier

Any of the recommended flooring finishes will also function as a vapour barrier. However, the flooring finish is not recommended as the air-barrier layer, as it would be unusual to seal the flooring finish to the air-barrier layer in the walls of house, and would be interrupted by interior partition walls and kitchen cabinets, etc.

The Air Barrier

The joints in the plywood subfloor need to be sealed so that it can function as the air-barrier layer.

Acoustical sealant installed on the top edge of the floor joists will seal joints in the plywood that run *along* the joists.

Acoustical sealant will need to be installed in the tongue-and-groove joints that span *between* the floor joists.

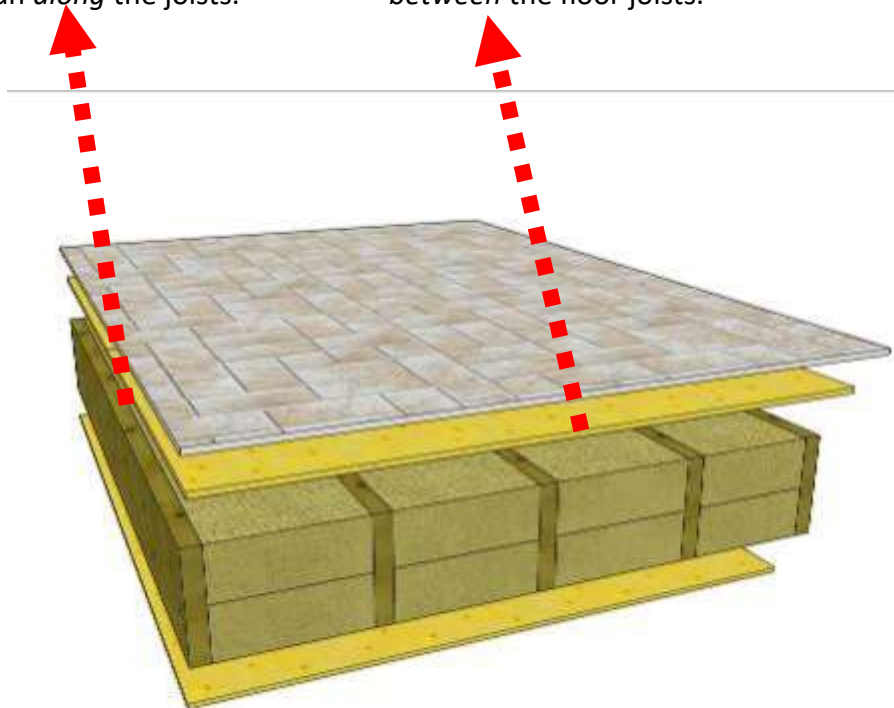

Acoustical sealant can be installed at the joints in the plywood, to make the plywood subfloor airtight.



The Insulation Cover

As the underside of the floor is sheltered from weather by the walls and roof, weather-barrier layers are not required. However, the insulation still needs to be held in place and covered to discourage animals from entering. Exterior-grade type-X gypsum-board sheathing can be used instead of plywood where added protection against fire is desired.

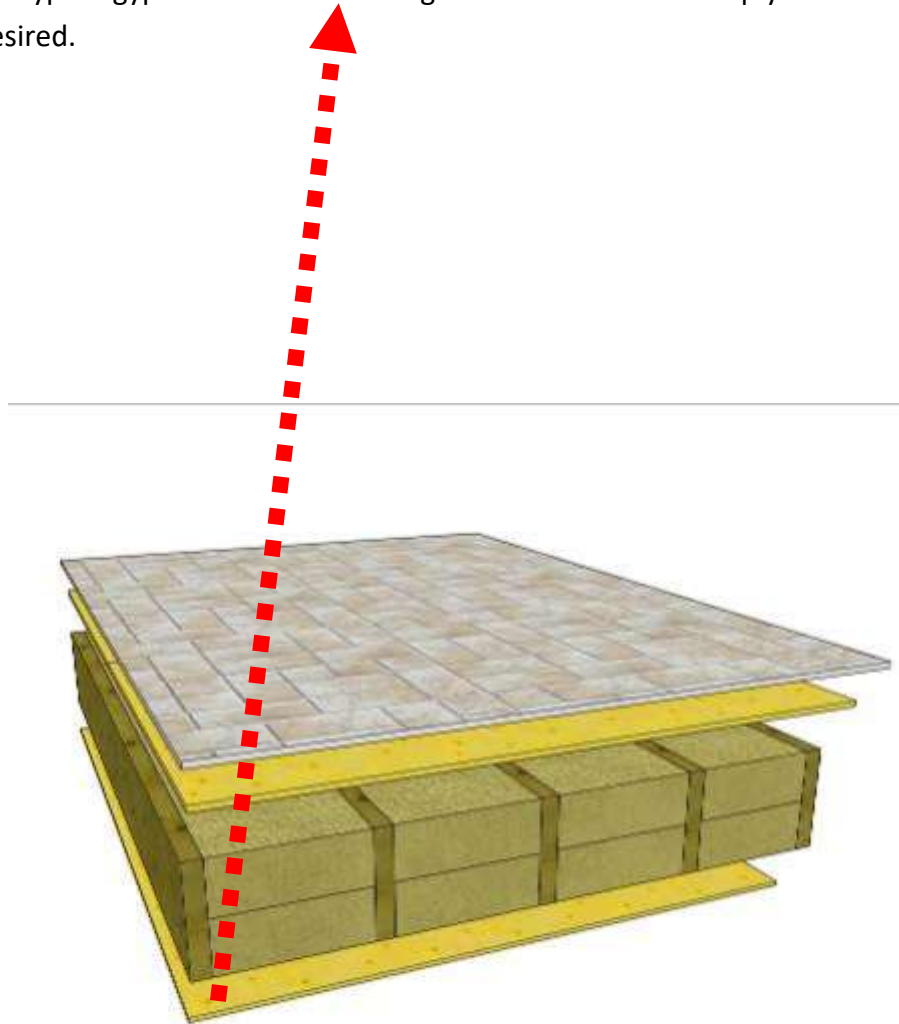

Plywood insulation cover highlighted in the traditional floor



FLOOR #2—THE TRADITIONAL HOT FLOOR

The traditional floor can be made into a hot floor by adding a layer of 2x6s on edge above the joists and then installing the flooring over top.



THE TRADITIONAL HOT-FLOOR VERSION 2X12 FLOOR WITH 2X6 SERVICE CAVITY
R-42 (EFFECTIVE)

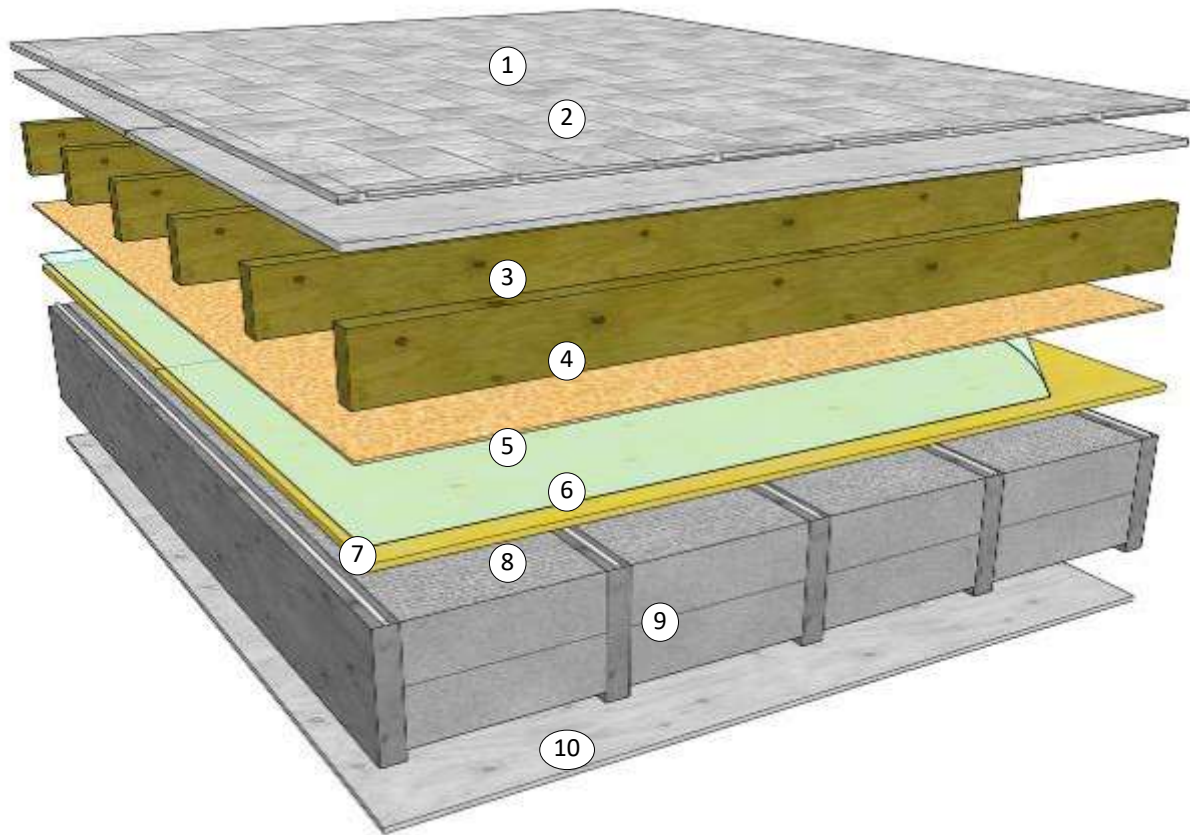

- ① Linoleum-sheet flooring
 - ② 5/8" T&G plywood
 - ③ 2x6 wood-floor joists @ 16" o.c.
 - ④ 1/4" OSB
 - ⑤ 6-mil poly
- Vapour Barrier + Air Barrier

- ⑥ 1/2" plywood
 - ⑦ Glue
 - ⑧ 11" mineral fibre batt; 2x5 1/2"
- **Insulation, R-48 (nominal)**
- ⑨ 2x12 wood-floor joists @ 16" o.c.
 - ⑩ 1/2" plywood
- Insulation cover



The Hot-Floor Layers

A 6-mil poly vapour barrier is required under the service cavity, which is open to the warm moist air inside the house. The laps in the 6-mil poly can be sealed with tape to make it function as the air-barrier layer too, but care is required to avoid damaging it during construction. A layer of 1/4" OSB is recommended to protect the 6-mil poly air barrier in the hot-floor version of the traditional floor.

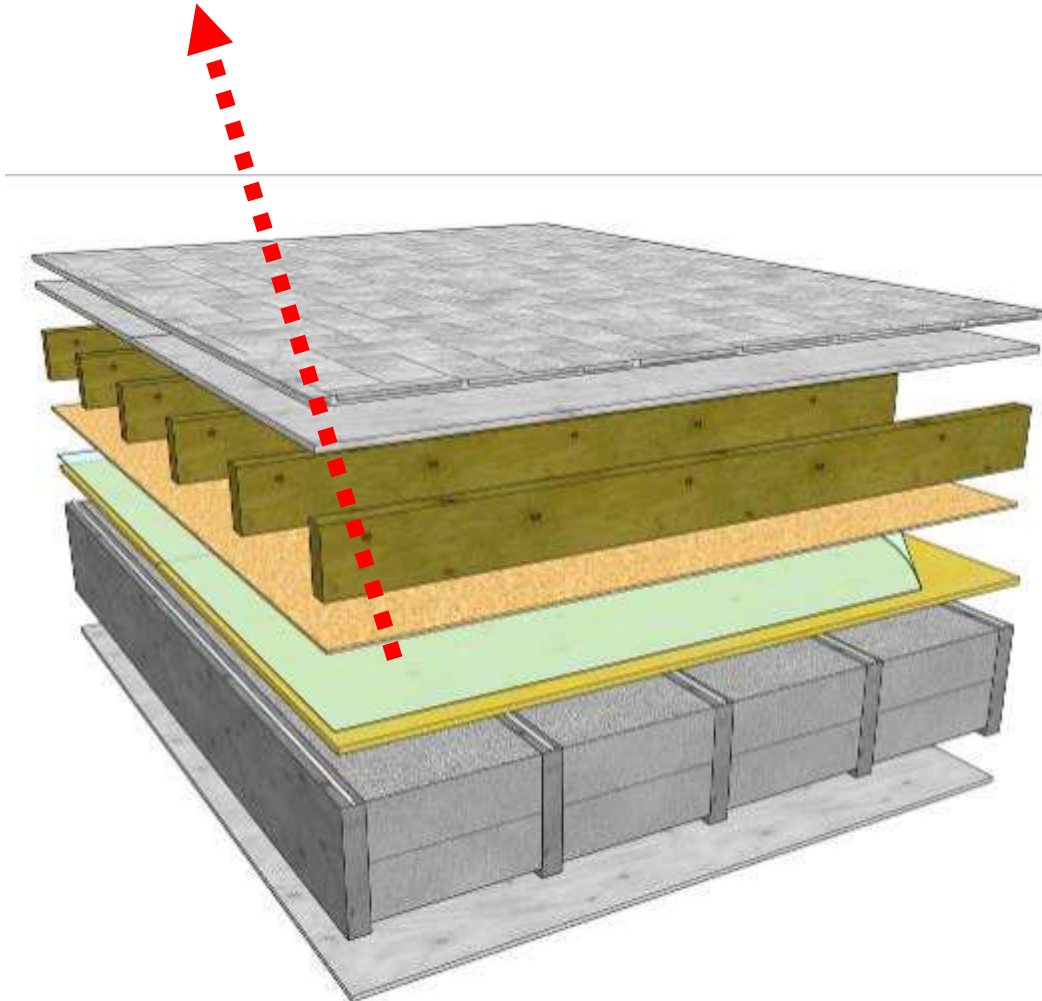

OSB layer that protects the air barrier highlighted in the hot-floor version of the traditional floor



FLOOR #3—I-JOIST HOT FLOOR

The I-Joist hot floor is the same as the hot-floor version of the traditional floor, except I-joists deeper than 2x12s are used to create more room for the batt insulation. This gives the floor a higher overall effective R-value, so that heat loss through the floor is reduced.

The I-Joists are also significantly stiffer and stronger than 2x12s, so they can span larger distances between foundation supports.



16" I-JOIST HOT FLOOR WITH 2X6 SERVICE CAVITY R-62 (EFFECTIVE)

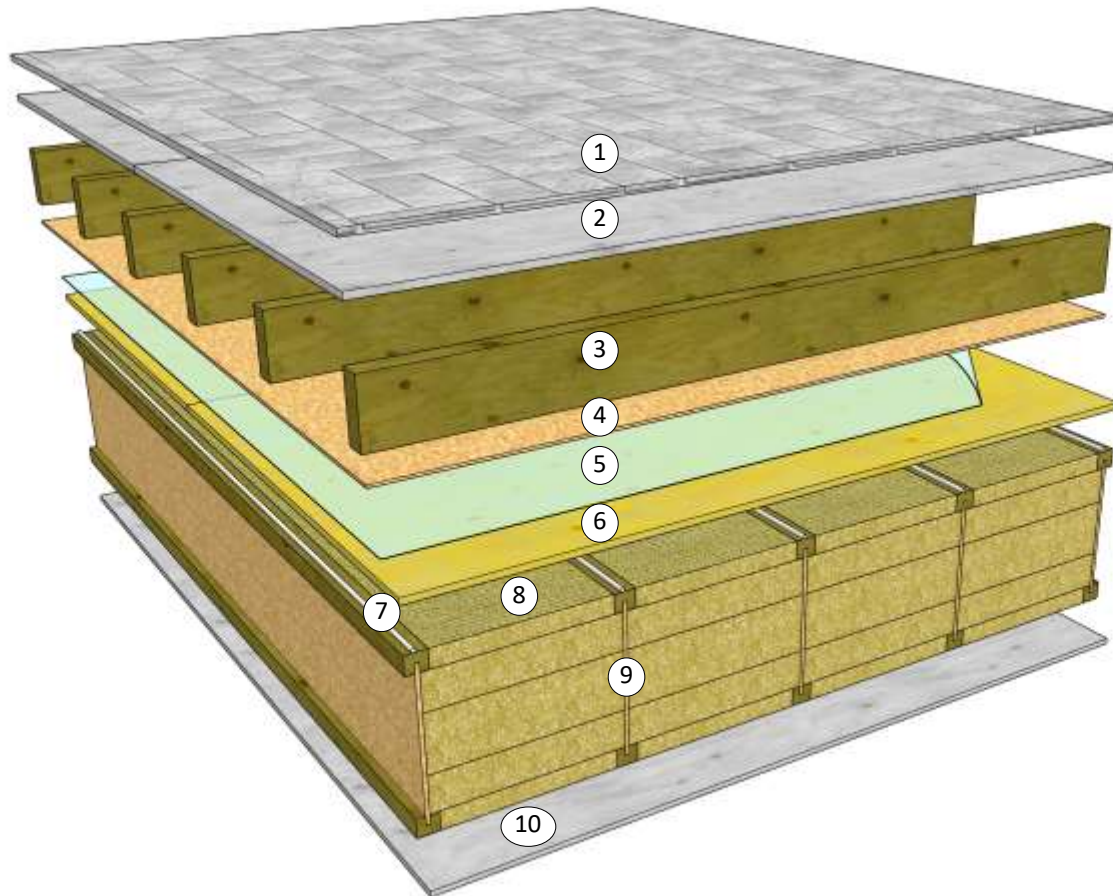

- ① Linoleum-sheet flooring
 - ② 5/8" T &G plywood
 - ③ 2x6 wood-floor joists @ 16" O/C
 - ④ 1/4" OSB
 - ⑤ 6-mil poly
- Vapour Barrier + Air Barrier

- ⑥ 5/8" T &G plywood
 - ⑦ Glue
 - ⑧ 16" mineral fibre batt; 1@5 1/2", 3@3 1/2"
→ Insulation, R-66 (nominal)
 - ⑨ 16" I-Joists @ 16" O/C
 - ⑩ 1/2" plywood
- Insulation cover



SUMMARY OF FLOORS

PART 2: Floors

(effective R-value)

Strengths

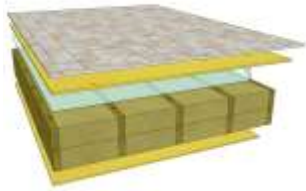

Roof # 1: **The Traditional**
(Basic 2x12 rafter roof)

(R-40)

- Lowest cost to construct

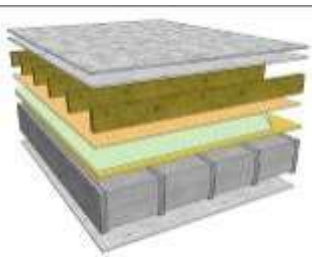

Roof #2: **The Traditional Hot-Floor Version** **(R-42)**

- Floor finish is warmer
- Has a space for pipes and air-ducting

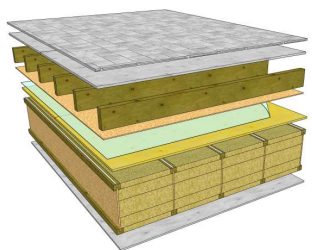

Roof #3: **I-Joist Hot-Floor Version**

(R-62)

- Floor finish is warmer
- Has a space for pipes and air-ducting



ADDITIONAL RESOURCES

OTHER RELATED GUIDES

- ***Housing Construction in Nunavik***, Société D’Habitation Du Québec
(habitation.gouv.qc.ca)
- ***Keeping the Heat In***, Natural Resources Canada
(www.nrcan.gc.ca)
- ***Illustrated Guide— R22+ Effective Walls in Residential Construction in British Columbia***, BC Housing
(www.bchousing.org)
- ***Illustrated Guide — R30+ Effective Vaulted & Flat Roofs in Residential Construction in British Columbia***, BC Housing
(www.bchousing.org)
- ***Illustrated Guide— Achieving Airtight Buildings***
(www.bchousing.org)
- ***Canadian Wood-Frame House Construction***, Canada Mortgage and Housing Corporation
(www.publications.gc.ca)
- ***Good Building Practices Guidelines***, Government of Nunavut
(www.gov.nu.ca)
- ***Illustrated Guide for Northern Housing Retrofits***
(<https://emrlibrary.gov.yk.ca/energy/illustrated-guide-for-northern-housing-retrofits-2016.pdf>)

BUILDING CODES & STANDARDS

- ***National Building Code of Canada***, National Research Council Canada
(www.nrc.canada.ca)
- ***ASHREA Standard 90.1***, American Society of Heating, Refrigerating, and Air Conditioning Engineers
(www.ashrae.org)
- ***CANADA BUILDING CODE FOR THE NORTH 1968***, National Research Council
(www.nrc.canada.ca)



Continued—ADDITIONAL RESOURCES

TECHNICAL INFORMATION

- ***Effective R Calculator for Walls***, Canadian Wood Council
(www.cwc.ca)
- ***Building Envelope Thermal Bridging Guide***, BC Hydro and BC Housing
(www.bchydro.com, www.bchousing.org)
- ***ASHREA Handbook of Fundamentals***, American Society of Heating, Refrigerating, and Air Conditioning Engineers
(www.ashrae.org)
- ***Builder Insight 08—Compatibility of Fasteners and Connectors with Residential Pressure Treated Wood***, BC Housing(www.bchousing.org)
- ***Canadian Building Digest***, National Research Council Publications Archive
(<https://nrc-publications.canada.ca/eng/search/>)
- ***Building Science Articles***, Building Science Corporation
(www.buildingscience.com)
- ***Building Science Calculators***, Cold Climate Housing Research Center
(www.cchrc.org)



APPENDIX

HOW TO DETERMINE THE MOST COST-EFFECTIVE OPTION

The following pages present a detailed example of the analysis involved to determine the most cost-effective wall, roof, or floor type, using mathematical calculations.



HOW TO DETERMINE THE MOST COST-EFFECTIVE OPTION

The most cost-effective option can be determined by using a basic energy-loss calculation and applying this to the cost of heating in your community. Then, the total cost of heating over the lifespan can be compared to the difference in cost between options.

Suppose the energy savings in heating over the lifespan are more than the option's increased construction cost. In that case, the option is cost-effective.

For example, assume that for a specific house design, it costs an extra \$10,000 to construct a wall option with more insulation than the code-minimum wall. The savings in heating energy from this additional insulation in the walls is then calculated to be \$400 per year, over an assumed 50-year lifespan. The total energy savings is \$20,000. As the \$20,000 in energy savings is much greater than the \$10,000 additional construction cost, the option with more insulation is more cost-effective than the code minimum.

Note: the house must last at least 25 years for it to become a cost-effective option. The break-even or pay-back period is 25 years, as it will take 25 years for \$400/year savings to equal the extra \$10,000 in construction cost.

The most cost-effective wall, roof, or floor for your community over its lifecycle will depend on:

- **Construction Cost** (the difference between options)
- **Lifespan**
- **Heating Degree Days (HDD)**
- **Heating Cost** (the difference between options)

The **construction cost** will vary among communities and over time, and should include the material, shipping and labour costs, etc. Construction costs are obtained from material suppliers, contractors, and shipping companies, etc.

The **lifespan** of a house is difficult to predict, and will vary among communities and even individual houses. The best indicator for lifespan of a future house is historical data from existing houses in the region with the same or similar construction. The service life of existing houses should be monitored and documented in a region to help with future decision-making. However, historical data on lifespan likely won't be available for the recommended options. This guide suggests considering a **minimum 50-year average lifespan**.



Continued—HOW TO DETERMINE THE MOST COST-EFFECTIVE OPTION

In Inuvialuit, **heating degree days (HDD)** range from 9,600 in Inuvik to 10,700 in Ulukhaktok.

The number of heating degree days for a community can be found in *The National Building Code of Canada 2015: Volume 1, Division B, Appendix C*, as shown in the image below.

Appendix C **Division B**

Table C-2 (Continued)

Province and Location	Elev., m	Design Temperature				Heating Degree Days Below 18°C	15 Min. Rain, mm	One Day Rain, 1/50, mm	Ann. Rain, mm	Moist. Index	Ann. Tot. Ppn., mm	Driving Rain Wind Pressure, Pa, 1/5	Snow Load, kPa, 1/50		Hourly Wind Pressures, kPa	
		January		July 2.5%									S _s	S _w	1/10	1/50
		2.5% °C	1% °C	Dry °C	Wet °C											
Watson Lake	685	-48	-48	26	16	7470	10	54	250	0.55	410	60	3.2	0.1	0.27	0.35
Whitehorse	655	-41	-43	25	15	6580	8	43	170	0.49	275	40	2.0	0.1	0.29	0.38
Northwest Territories																
Inuvik	5	-42	-44	26	17	9600	8	49	115	0.67	250	60	2.0	0.1	0.37	0.48
Echo Bay / Port Radium	195	-42	-44	22	16	9300	8	60	160	0.70	250	80	3.0	0.1	0.41	0.53
Fort Good Hope	100	-43	-45	26	18	8700	9	60	140	0.60	280	80	2.9	0.1	0.34	0.44
Fort McPherson	25	-44	-46	26	17	9150	8	50	145	0.67	315	60	3.2	0.1	0.31	0.40
Fort Providence	150	-40	-43	28	18	7620	10	71	210	0.56	350	100	2.4	0.1	0.27	0.35
Fort Resolution	160	-40	-42	26	18	7750	10	60	175	0.61	300	140	2.3	0.1	0.30	0.39
Fort Simpson	120	-42	-44	28	19	7660	12	76	225	0.56	360	80	2.3	0.1	0.30	0.39
Fort Smith	205	-41	-43	28	19	7300	10	65	250	0.56	350	80	2.3	0.2	0.30	0.39
Hay River	45	-38	-41	27	18	7550	10	60	200	0.62	150	140	2.4	0.1	0.27	0.35
Holman / Ulukhaktok	10	-39	-41	18	12	10700	3	44	80	0.93	250	120	2.1	0.1	0.66	0.86
Inuvik	45	-43	-45	26	17	9600	8	49	115	0.67	425	60	3.1	0.1	0.37	0.48
Mould Bay	5	-44	-46	11	8	12900	3	33	25	0.94	100	140	1.5	0.1	0.45	0.58
Norman Wells	65	-43	-45	26	18	8510	9	60	165	0.57	320	80	3.0	0.1	0.34	0.44

Snapshot image of the climatic data for Inuvialuit communities in Table C-2 from the National Building Code.

Some math is required to determine the difference in heating costs between the two wall options. The following equation can be used to calculate energy loss through walls, roof, or floor of a house. Once heat loss is calculated, multiply it by the cost of energy in \$/kW·hr to get the annual cost of heat loss through the walls, roof, or floor.

$$\text{Annual heat loss} = \left(\frac{\text{Wall Area}}{\text{RSI}} \right) \times (\text{Heating Degree Days}) \times \left(24 \frac{\text{Hr}}{\text{Day}} \right) \times \left(\frac{1 \text{ kW}}{1000 \text{ W}} \right)$$

↑ heat loss per year in kWh
↑ effective R-value of the wall in RSI
↑ unit conversion days to hours

↑ unit conversion of watts to kilowatts



Continued—HOW DO I CHOOSE WHICH R-VALUE TO USE?

The following example shows how to put this all together. Say you will build a new house in Ulukhaktok, and you need to decide to build one of two wall types: a code-minimum R-23 effective wall or a highly insulated R-49 effective wall. You already know the following:

- The R-49 wall costs \$15 per square foot more to construct than the R-23 wall.
- Heating oil costs \$1.70/L (house heating is by oil-burning furnace with 85 percent efficiency).
- House shape: 48 feet wide by 24 feet deep with walls that are 9 feet high on the exterior.
- 296 square feet of windows.

You're not sure if the energy savings of the R-49 wall are worth the extra construction. The calculations below show that it is.

1) Calculate the wall area:

$$\text{Gross Wall Area} = (48\text{ft} + 48\text{ft} + 24\text{ft} + 24\text{ft}) \times 9\text{ft} = 1,296 \text{ ft}^2$$

$$\text{Wall Area} = \text{Gross Wall Area} - \text{total window area}$$

$$\text{Wall Area} = 1,296 \text{ ft}^2 - 296 \text{ ft}^2 = 1,000 \text{ ft}^2$$

$$\text{Wall Area} = 1,000 \text{ ft}^2$$

2) Calculate the extra construction cost to build the R-49 wall instead of the R-23 wall:

$$\text{Extra cost} = 1,000 \text{ ft}^2 \times \frac{\$15}{\text{ft}^2} = \$15,000$$

Extra Construction Cost = \$15,000

3) Calculate the annual heat loss for each wall option using the heat-loss equation (in SI units):

$$\text{Annual heat loss} = \left(\frac{\text{Wall Area}}{\text{RSI}} \right) \times (\text{Heating Degree Days}) \times \left(\frac{24 \text{ Hr}}{\text{Day}} \right) \times \left(\frac{1 \text{ kW}}{1000\text{W}} \right)$$

Diagram annotations:

- Red arrow from "wall area in m²" points to "Wall Area".
- Red arrow from "effective R value of the wall in RSI" points to "RSI".
- Red arrow from "unit conversion days to hours (h)" points to "24 Hr / Day".
- Red arrow from "unit conversion of watts to get heat loss in kilowatts (kW)" points to "1 kW / 1000W".
- Red arrow from "heat loss per year in kilowatt-hours (kWh)" points to the entire equation.



Continued—HOW DO I CHOOSE WHICH R-VALUE TO USE?

3a) Convert wall area to square metres: $Wall\ Area = 1,000\ ft^2 \times \left(\frac{1\ m}{3.28\ ft}\right)^2 = 93\ m^2$

3b) Convert R-values to RSI

$$R23 \times \frac{1\ RSI}{R5.678} = 4.05\ RSI$$

$$R49 \times \frac{1\ RSI}{R5.678} = 8.63\ RSI$$

3c) Look up the heating degree days (HDD) for Ulukhaktok in Appendix C of the *National Building Code*:
10,700 HDD

3d) Put metric units into the equation to get annual heat loss:

$$Annual\ heat\ loss_{(R23)} = \left(\frac{93\ m^2}{4.05}\right) \times (10,700\ HDD) \times \left(24\ \frac{Hr}{Day}\right) \times \left(\frac{1\ kW}{1000W}\right) = 5,897\ kWh$$

$$Annual\ heat\ loss_{(R49)} = \left(\frac{93\ m^2}{8.63}\right) \times (10,700\ HDD) \times \left(24\ \frac{Hr}{Day}\right) \times \left(\frac{1\ kW}{1000W}\right) = 2,767\ kWh$$

4) Calculate the energy savings for the R-49 wall, in kWh:

$$Annual\ Energy\ Savings = Annual\ heat\ loss_{(R23)} - Annual\ heat\ loss_{(R49)}$$

$$Annual\ Energy\ Savings = 5,897\ kWh - 2,767\ kWh = 3,130\ kWh$$



Continued—HOW DO I CHOOSE WHICH R-VALUE TO USE?

5) Convert the cost of oil to the cost of heat energy in \$ /kWh:

There are 139,000 Btus in one gallon (3.785 L) of oil; or 36,724 Btu/L

$$\text{Oil Energy Content} = 36724 \text{ Btu/L} \cdot \left(\frac{0.293 \text{ Wh}}{\text{Btu}}\right) \cdot \left(\frac{\text{kW}}{1000 \text{ W}}\right) = 10.76 \text{ kWh/L}$$

$$\text{Furnace Heat Output} = 85\% \times 10.76 \frac{\text{kWh}}{\text{L}} = 9.1 \text{ kWh/L}$$

One litre of oil provides 9.1 kWh of heat via the furnace and costs \$1.70 per litre

$$\text{Energy Cost}_{\text{oil}} = \frac{\$1.70}{9.1 \text{ kWh}} = \$0.19/\text{kWh}$$

The table below can be used instead for converting the cost of heating oil to \$ /kWh:

Cost of Oil (\$ / Liter)	Cost of Heat Energy based on 85% efficiency oil burning furnace (\$ / kWh)
\$1.00	\$0.11
\$1.10	\$0.12
\$1.20	\$0.13
\$1.30	\$0.14
\$1.40	\$0.15
\$1.50	\$0.16
\$1.60	\$0.18
\$1.70	\$0.19
\$1.80	\$0.20
\$1.90	\$0.21
\$2.00	\$0.22



Continued—HOW DO I CHOOSE WHICH R-VALUE TO USE?

6) Calculate the savings in heating cost over the lifespan of the house:

*Total Cost Savings = Annual Energy Savings × Life Span × Energy Rate Cost*_{oil}

$$Total\ Cost\ Savings = 3,103 \frac{kWh}{year} \times 50\ years \times \frac{\$0.19}{kWh} = \$29,478.50$$

Total Cost Savings = \$29,478.50

The lifespan energy saving of \$28,478.50 is much more than the additional construction cost of \$15,000 for the R49 wall. Therefore, the R49 wall is the more cost-effective wall option over the R23 wall from a lifecycle perspective.

Note: The math in the equation can be adjusted with algebra to present the comparison in different ways by solving for other variables: lifespan or energy-rate cost:

- **\$0.096/kWh** is the break-even energy cost (if the cost of heating is less than \$0.096/kWh, the R49 wall would not be the most cost-effective)
- **25.4 years** is the payback period (the house needs to last at least 25.4 years for the R49 wall option to make sense from a cost perspective).

Note: The time-value of money is not factored into this analysis. For example, the extra \$15,000 in construction cost will most likely have greater value in 50 years if invested. The savings in energy cost are in future dollars, which is not as valuable as money in the present, assuming positive interest rates over time.

Also, note that the energy cost will likely increase over time, so that the corresponding savings will be more significant.



Continued—HOW DO I CHOOSE WHICH R-VALUE TO USE?

Looking at all the options: The bigger picture

The higher R-value options will cost more to construct, as shown in the graph below, and the increase in construction cost is relatively constant. Beyond a certain point, adding more insulation will be much more expensive (note the large cost increase from R49 to R60).

The higher R-value options will result in lower heating costs, but the biggest change in savings occurs between the lower R-value options. Adding insulation is subject to diminishing returns. The savings are smaller between the higher R-value options.

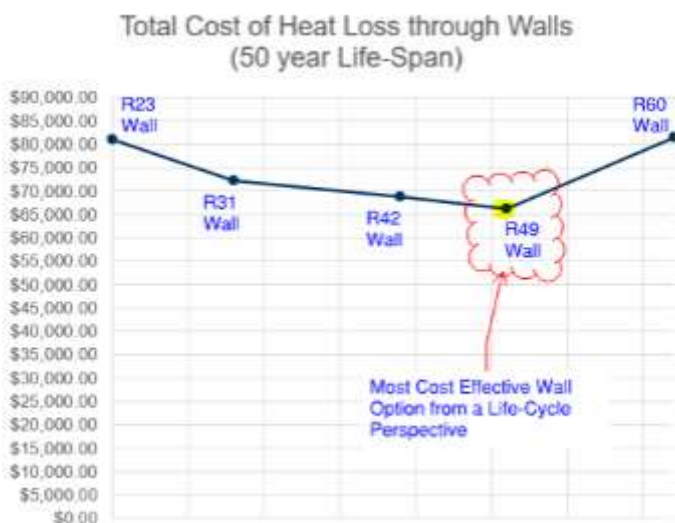
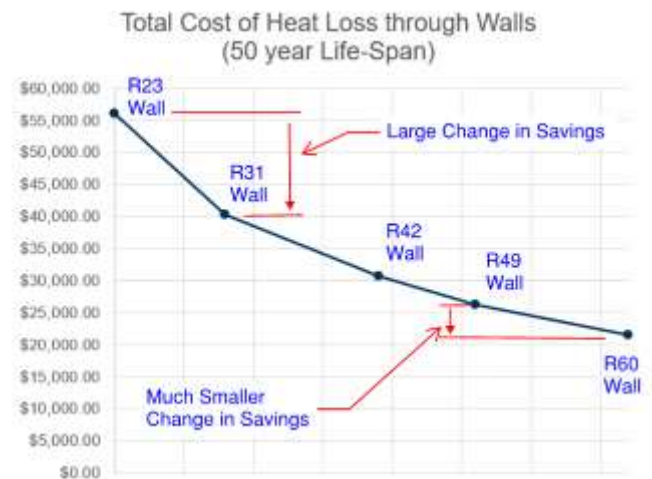

When the construction cost and lifecycle heating cost are added together for each of the R-value options, the lowest-cost option becomes clear.

Even though the R23 wall has the lowest construction cost, its high heating costs make it more expensive than the R49 wall.

Similarly, even though the R60 wall has very low heating costs, very high construction costs make it more expensive than the R49 wall.

Any of the wall options could be the most cost-effective. There will be variation among communities in the north. The graphs above are only examples of how to calculate and compare lifecycle costs. The most cost-effective option needs to be calculated based on a community's specific cost of heating and construction, heating degree days, and historical data on lifespan.



This technical booklet was developed to help community decision makers and building officers choose from a variety of technical options in the delivery of residential housing for Indigenous communities in remote northern Inuvialuit.

IMPORTANT NOTE

This booklet is primarily focused on modern airtight house construction, although some traditional non-airtight approaches to housing are also discussed.

A mechanical ventilation system needs to be included in the design and construction of an airtight house. Refer to Technical Booklet #2 on ventilation.

ACKNOWLEDGEMENTS

This guide was funded and commissioned by FNNBOA and the National Research Council of Canada (NRC), and was prepared by Morrison Hershfield Limited. Additional funding was provided by Natural Resources Canada (NRCan), Canada Mortgage and Housing Corporation (CMHC), and Indigenous Services Canada.

Acknowledgement is extended to all those who participated as part of the project team, or external reviewers, or representatives from northern communities providing insight into how to make this document useful.

AUTHORS

Morrison Hershfield Limited

EXTERNAL REVIEWERS & CONTRIBUTORS

Alain Fournier, Founding Partner—EVOQ Architecture (Montreal, QC)

Bruno Di Lenardo, Evaluation Officer—NRC Construction Research Centre (Ottawa, ON)

David T Fortin, Principal Architect/Associate Professor and Director—Laurentian University (Sudbury, ON)

John Kiedrowski, Project Manager—FNNBOA (Ottawa, ON)

Keith Maracle, President—FNNBOA (Shannonville, ON)

Larry Jones, Senior Project Officer—NWT Housing Corporation (Yellowknife, NWT)

Mihailo Mihailovic, Evaluation Officer—NRC Construction Research Centre (Ottawa, ON)



**First Nations National Building Officers
Association (FNNBOA)**

5731 Old Hwy #2
P.O. Box 219
Shannonville, Ontario
K0K 3A0

<https://www.fnnboa.ca/contact-fnnboa>